

Testing LTE-Advanced (Rel. 10)

Application Note

Products:

- R&S®SMW200A
- R&S®SMBV100A
- R&S®CMW500
- R&S®RTO-1044
- R&S®FSW
- R&S®FSV3000
- R&S®FSVA3000
- R&S®FPS
- R&S®RTO
- R&S®TS8980

LTE-Advanced comprises multiple features enhancing the basic LTE technology firstly specified in 3GPP Release 8. LTE including the LTE-Advanced improvements was approved by ITU to comply with IMT-Advanced requirements and thus being a true 4G mobile communication system. The different technology components of LTE-Advanced have different market priorities and require different testing strategies.

This application note summarizes the Rohde & Schwarz test solutions for LTE-Advanced (Release 10) using Vector Signal Generators, Signal and Spectrum Analyzers and the Wideband Radio Communication Tester.

Note:

Visit our homepage for the most recent version of this application note (www.rohde-schwarz.com/appnote/1MA166).

Contents

1	Introduction.....	3
2	Testing of LTE-Advanced (Rel. 10).....	4
3	Appendix.....	41
4	Rohde & Schwarz.....	43

1 Introduction

LTE (Long Term Evolution) Release 8 standardization within the 3GPP (3rd Generation Partnership Project) has come to a mature state where changes in the specification are limited to corrections and bug fixes. Since end 2009, LTE mobile communication systems are commercially deployed as an evolution of GSM (Global system for mobile communications), UMTS (Universal Mobile Telecommunications System), CDMA2000 (Code Division Multiple Access) and TD-SCDMA (Time Division Synchronous Code Division Multiple Access) networks.

The ITU (International Telecommunication Union) coined the term IMT-Advanced to identify mobile systems whose capabilities go beyond those of IMT 2000 (International Mobile Telecommunications). In September 2009 the 3GPP Partners made a formal submission to the ITU proposing that LTE Release 10 & beyond (LTE-Advanced) should be evaluated as a candidate for IMT-Advanced. In October 2010 LTE-Advanced successfully completed the evaluation process in ITU-R complying with or exceeding the IMT-Advanced requirements and thus became an acknowledged 4G technology. A complete LTE-Advanced technology introduction is available with a Rohde & Schwarz white paper [1].

The different LTE-Advanced technology components illustrated in [1] naturally have different market requirements and also require different testing strategies. Section 2 of this application note discusses the testing aspects of each technology component in LTE-Advanced and describes available test solutions in the Rohde & Schwarz product portfolio.

The following abbreviations are used in this application note for Rohde & Schwarz test equipment:

- The R&S®SMW200A vector signal generator is referred to as the SMW.
- The R&S®SMBV100A vector signal generator is referred to as the SMBV.
- The R&S®FSW signal and spectrum analyzer is referred to as the FSW.
- The R&S®FSV3000 spectrum analyzer is referred to as the FSV.
- The R&S®FSVA3000 spectrum analyzer is referred to as the FSVA.
- The R&S®FPS spectrum analyzer is referred to as the FPS.
- The SMW and SMBV are referred to as the SMx.
- The FSW, FSV and FPS are referred to as the FSx.
- The R&S®CMW500 wideband radio communication tester is referred to as CMW500
- The R&S®TS8980 LTE RF Test System is referred to as TS8980

2 Testing of LTE-Advanced (Rel. 10)

2.1 LTE-A features (Release 10)

Generally each of the LTE-Advanced technology components (see [Figure 2-1](#)) can be considered as single optional feature to be supported on both infrastructure and end user device side. I.e. whether or not to implement e.g. carrier aggregation in the network is driven by operator requirements and infrastructure manufacturer implementation capabilities. Likewise the implementation of the various LTE-Advanced features at the user device side depends on individual chip set and user device manufacturer plans. The sections below discuss the testing aspects of each single technology component. However this certainly does not prevent the implementation and consequently testing of multiple features in a single Device Under Test (DUT).

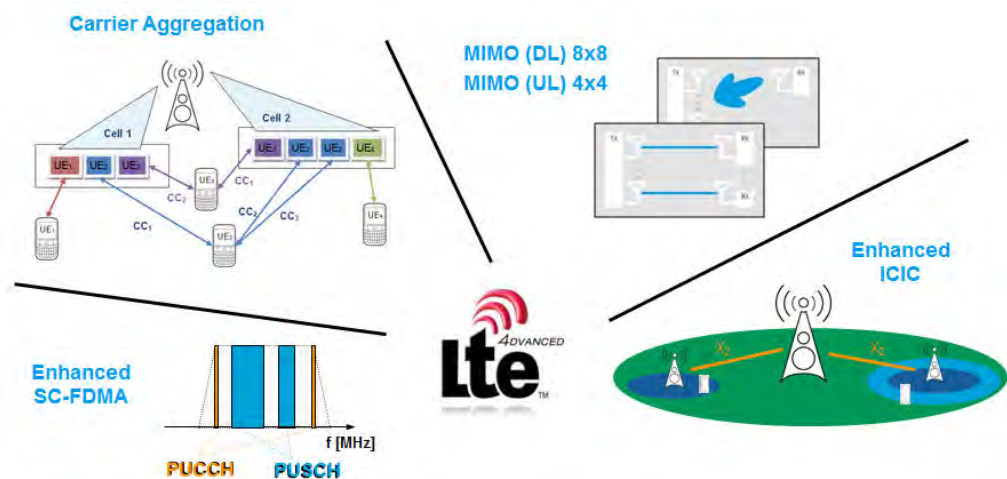

Figure 2-1: Main LTE-Advanced technology components

The relaying feature is not included in this application note although it is mentioned in [1], since relaying was not completed in 3GPP Release 10 timeframe but moved to 3GPP Release 11.

2.1.1 Carrier Aggregation (CA)

2.1.1.1 Band Aggregation

As illustrated in [1] carrier aggregation introduces the capability to aggregate up to five LTE Release 8 carriers, although practical implementations specifically at the terminal side are restricted to two DL carrier and one UL carrier (potentially also two UL carriers). Three different modes of carrier aggregation exist within LTE-Advanced:

- intra-band contiguous

- intra-band non-contiguous
- inter-band

3GPP Release 10 already comprises intra-band contiguous and inter-band CA, whereas intra-band non-contiguous CA has not been implemented until 3GPP Release 11. Intra-band describes the aggregation of component carriers within the same frequency band in a contiguous or non-contiguous way. For inter-band carrier aggregation the two component carriers reside in different frequency bands. Figure 2-2 visualizes the different modes being defined for carrier aggregation.

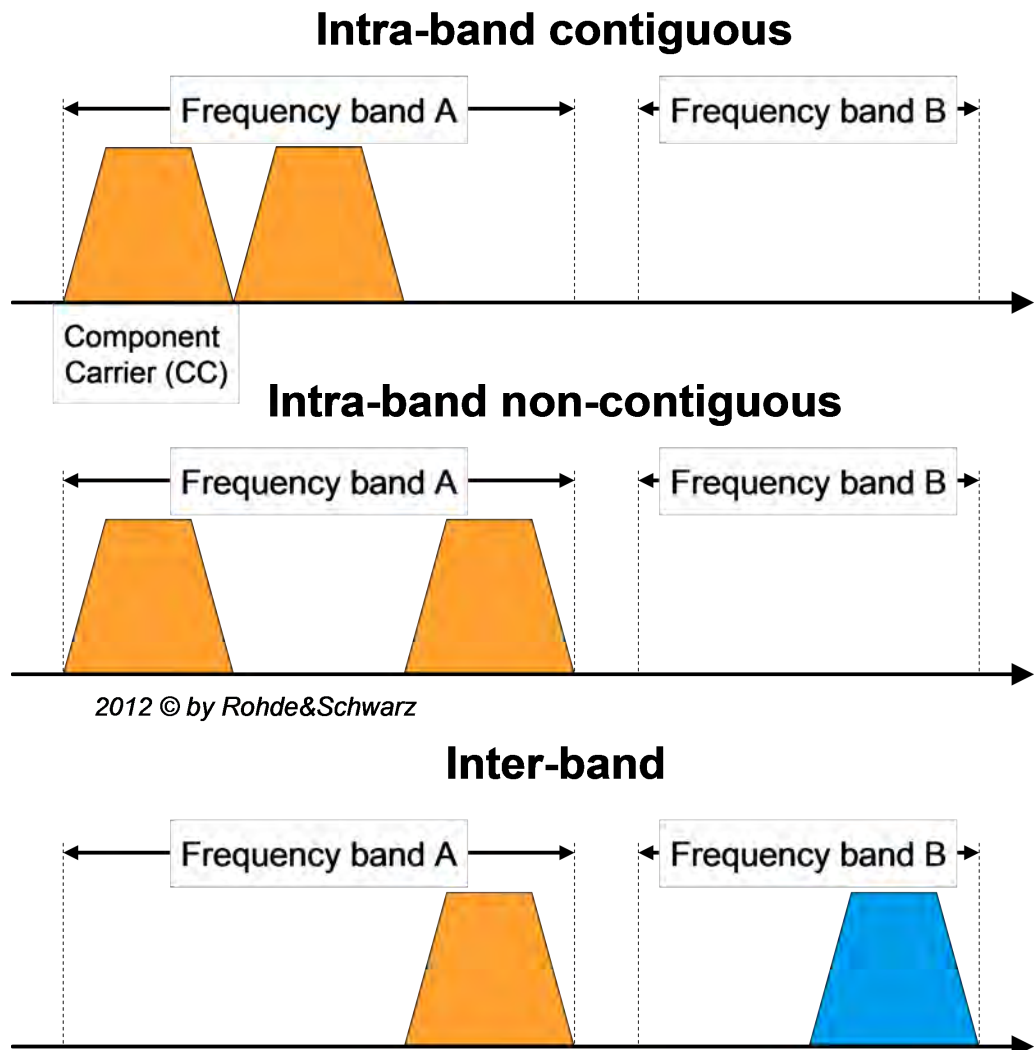

Figure 2-2: Modes of carrier aggregation

For carrier aggregation the main test challenge from RF perspective is to verify simultaneous transmission of multiple carriers in terms of e.g. modulation accuracy or unwanted intermodulation products. Additionally components like power amplifier need to work with the required number of carriers as input signal on both RF and baseband level. Furthermore, when receiving a carrier aggregation signal at the end user device side, the protocol behavior within the device has to be tested. This includes verification

of the scheduling signaling, measurement reporting, handover procedures and eventually E2E performance, i.e. demonstrating data rate capabilities. From conformance testing perspective a number of new certification tests are defined for RF, RRM and protocol. Finally performance verification in the field is required.

2.1.1.2 HARQ ACK/NACK procedure for multiple cells, PUCCH format 3

The ACK/NACK feedback in the PUCCH signals correct reception of transport blocks in the downlink direction. PUCCH format 3 allows now ACK/NACK reporting for carrier aggregation scenarios resulting into multiple cells received by a single UE. It allows to ACK/NACK multiple transport blocks on multiple carriers in a single extended message.

2.1.2 Enhanced SC-FDMA

[1] describes the uplink air interface enhancements introduced into LTE-Advanced. For enhanced SC-FDMA it is essentially the simultaneous transmission of PUSCH and PUCCH and to allow two clusters of adjacent subcarriers to be used (see Figure 2-3). The feature serves to improve spectral efficiency in the uplink because two clusters provide better frequency selective gain. However, the downside is increased linearity requirements at the user device transmitter, since simultaneous PUCCH/PUSCH and clustered operation will increase the peak to average ratio of the signal and also will generate more unwanted intermodulation products.

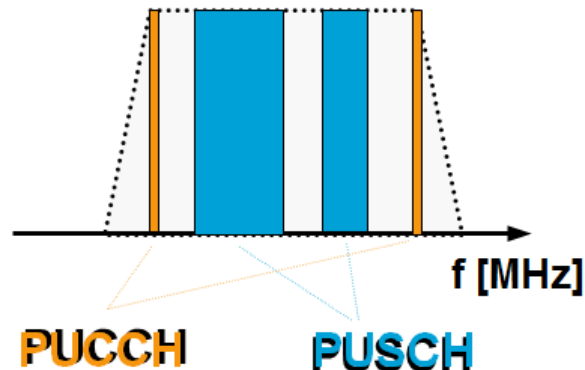

Figure 2-3: Simultaneous PUCCH/PUSCH and clustered uplink operation

2.1.3 Enhanced ICIC (eICIC)

As illustrated in [1] eICIC introduces a time domain based coordination method to avoid interference between cells specifically for heterogeneous network topologies (see Figure 2-4). So called almost blank subframes (ABS) are configured that suppress data transmission in a specific cell layer as much as possible. Consequently channel state information reporting from the device to the network becomes dependent on the ABS configuration in use. From a testing perspective the main requirement is to verify CSI reporting from a device for specific ABS scenarios. In real life networks the config-

uration of ABS patterns is operator and/or infrastructure dependent. This requires a flexible test environment to be configured according to individual testing needs.

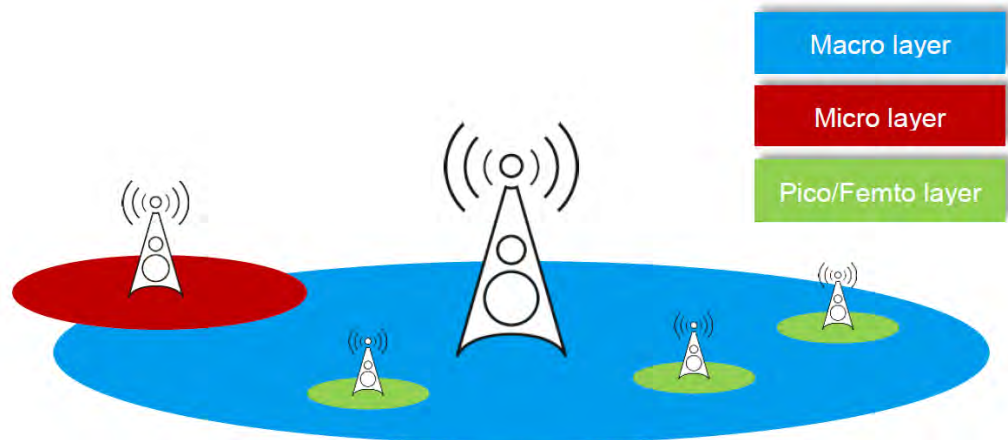

Figure 2-4: Heterogeneous network topology

Generally the behavior of the device under test has to be verified and therefore RF only measurements based on signal generators and signal analyzers are not required.

2.1.4 Enhanced MIMO schemes

LTE Release 8 supports multiple input / output (MIMO) antenna schemes. In downlink direction up to four transmit antennas may be used whereas the maximum number of codewords is two irrespective of the number of antenna ports. In uplink direction only MU-MIMO is used, i.e. there is only one modulated symbol stream per UE to be received by the eNodeB, whereas multiple UEs may transmit on the same time-frequency resource. LTE-Advanced extends the MIMO capabilities of LTE Release 8 to now supporting (see Figure 2-5,[1]):

- Downlink: eight (8) layers
- Uplink: four (4) layers

To support up to eight layers in the downlink, the new transmission mode (TM) 9 was introduced.

The enhanced downlink scheme is an extension of the existing scheme and in uplink direction the existing downlink scheme is essentially reused. Consequently testing the enhanced MIMO schemes requires similar methods than known from LTE Release 8. A description on how to generate and analyze MIMO signals is available in [4].

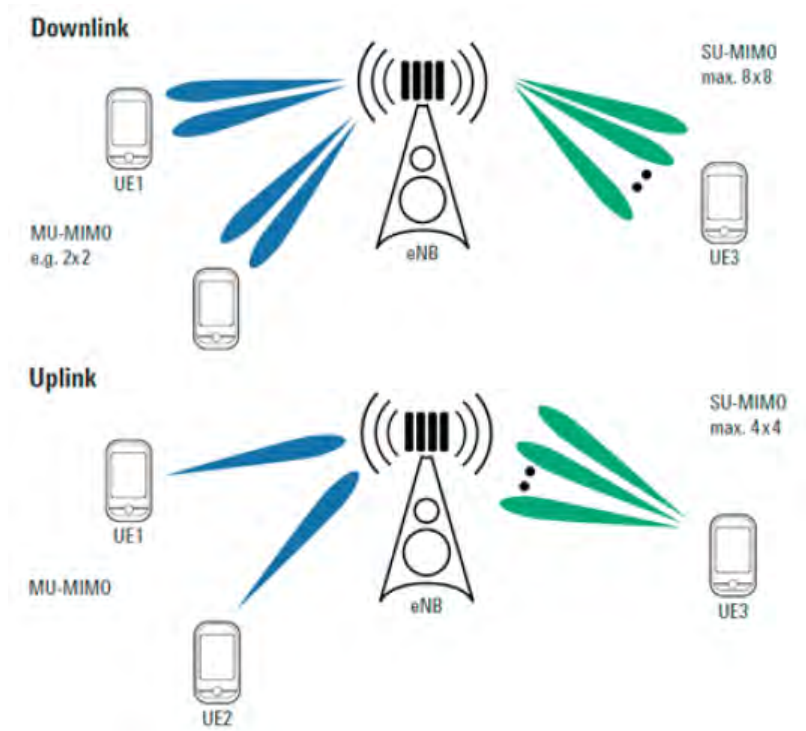

Figure 2-5: Supported transmit layers in LTE-Advanced

2.2 LTE-A baseband and RF signal generation

R&S signal generators offer many features that are particularly helpful when generating signals with multiple component carriers and MIMO according to LTE-Advanced requirements. This is especially true for the multi-path concept of the SMW signal generator which combines up to four independent signal generators in one single instrument. The SMW includes up to two RF paths in the main instrument. In addition, the SMW can handle up to eight RF paths with additional RF sources like the SGS or SGT.



Figure 2-6: SMW Vector Signal generator

The multi-path concept of the SMW allows configuration of each baseband according to individual testing needs (see Fig. 3-2, example generating a LTE and UMTS signal) or different MIMO modes. With the option SMW-K75 higher order MIMO modes like

8x4, 4x8 and 4x4 for 2 component carriers (CC) are possible. As an option in addition fading is available.

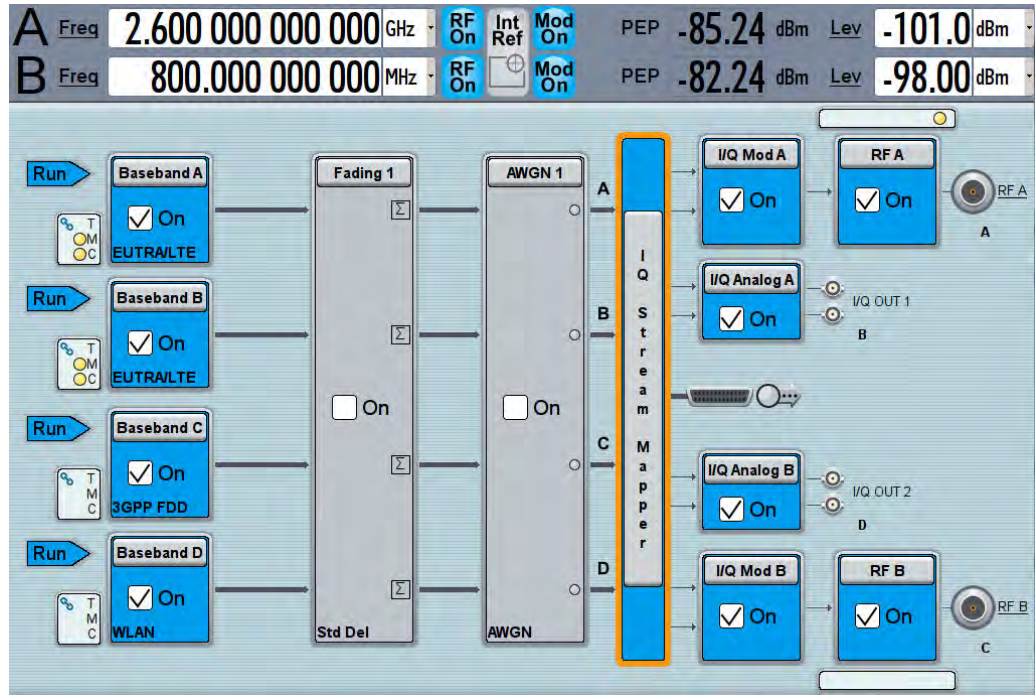

Figure 2-7: SMW example with four different signals

The SMW-K85 option allows testing of LTE-Advanced physical layer features in line with the 3GPP Release 10 standard. It covers downlink and uplink signal generation. SMW-K85 requires the basic LTE functionality being installed on the equipment (SMW-K55 LTE option).

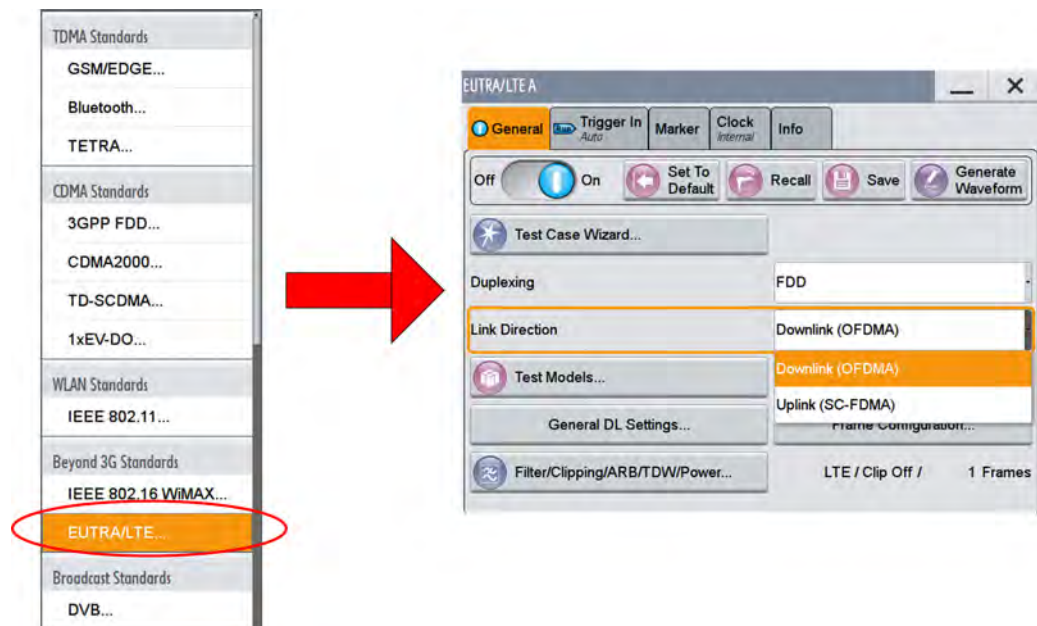

Figure 2-8: Start of the LTE standard and Link Direction.

2.2.1 Carrier aggregation (CA) generation

In accordance with 3GPP Release 10 up to five carriers may be aggregated. Each carrier can be given an individual bandwidth. In principle, all component carriers can be generated by a single baseband, if the baseband bandwidth fits to the wanted carrier aggregation scenario. If the baseband bandwidth is not sufficient, a second baseband is needed. Note the different baseband bandwidths:

- SMW: 160 MHz or 2000 MHz (optional)
- SMBV: 120 MHz

Within the carrier aggregation settings individual frequency-, power- and delay offsets can be configured. Each single component carrier can be switched on or off.

The SMW supports special system settings with the **System Configuration** feature e.g. for CA with 2x2 MIMO or 4x4 MIMO. This allows an easy configuration of multiple baseband settings by configuring only one baseband.

2.2.1.1 CA in the Downlink

After selecting *EUTRA/LTE* from the baseband configuration menu, within the *General DL Settings* a carrier aggregation signal can be easily configured (see [Figure 2-9](#)).

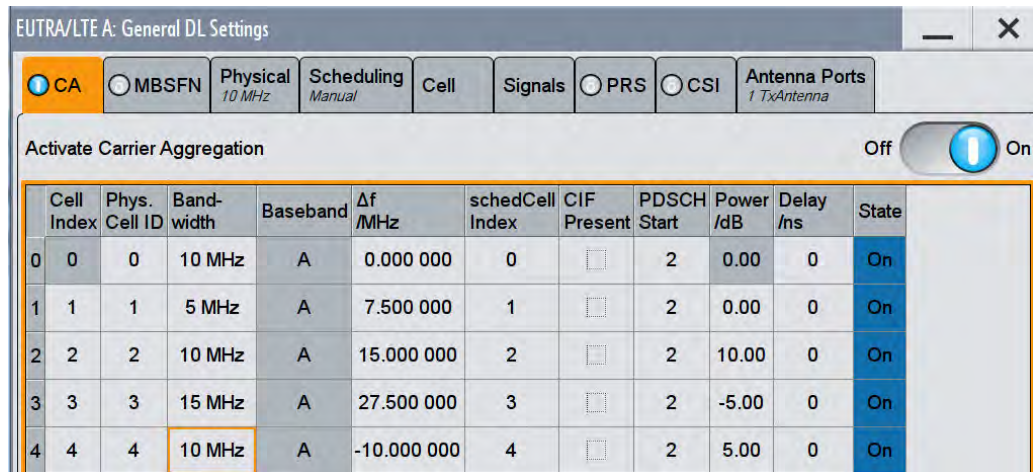
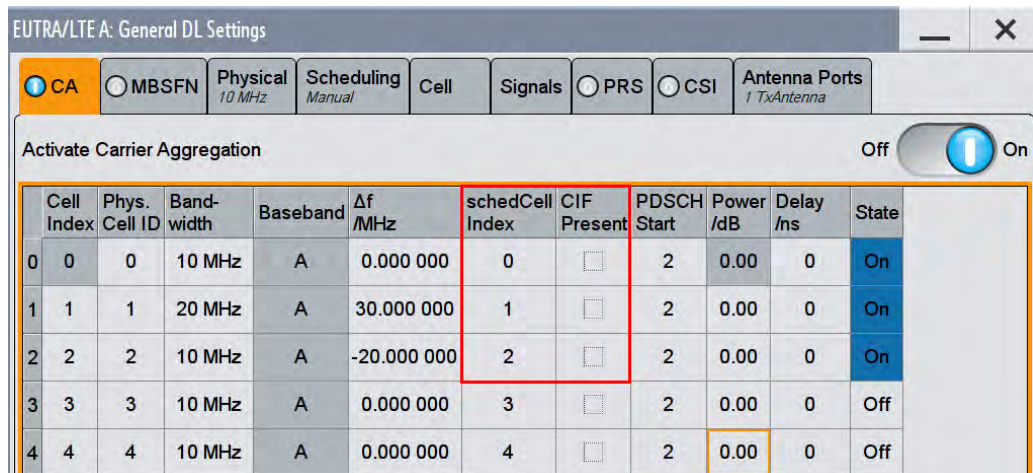

Figure 2-9: Carrier aggregation settings with up to five carriers in one baseband (SMW-K85). The carrier with cell index 0 is the Primary Component Carrier (PCC)

The number of symbols used for the control information may be different for each Component Carrier (CC). It is set by the Control Region for PDCCH and determined by the parameter PDSCH Start. In the case of cross-carrier scheduling the UE needs to be informed about this.

As illustrated in [1] cross carrier scheduling is an optimization method to schedule resources to a single user on different carriers from one PDCCH on the primary component carrier. The SMx-K85 enables cross-carrier scheduling due to the Carrier Indicator Field (CIF) present. Furthermore the parameter schedCellIndex needs to be set to the cell index number of the PCC. Figure 2-10 illustrates the different settings without (upper part) and with cross carrier scheduling (lower part) for a simple three component carrier scenario.



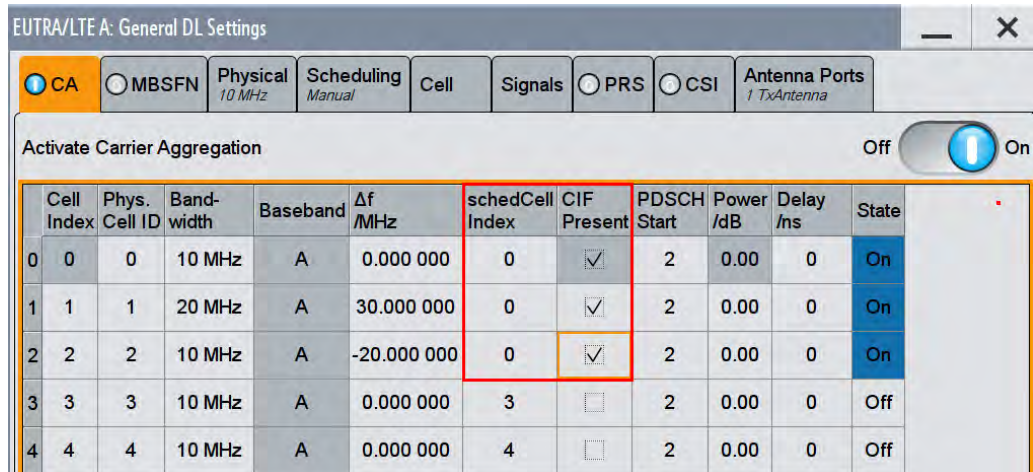

Figure 2-10: simple CA (upper part) and cross carrier scheduling (lower part)

When applying cross carrier scheduling, there is additionally the need to configure each individual user such that the Cell Index field and CFI field within the PDCCH carries the correct scheduling PCC information (Figure 2-11).

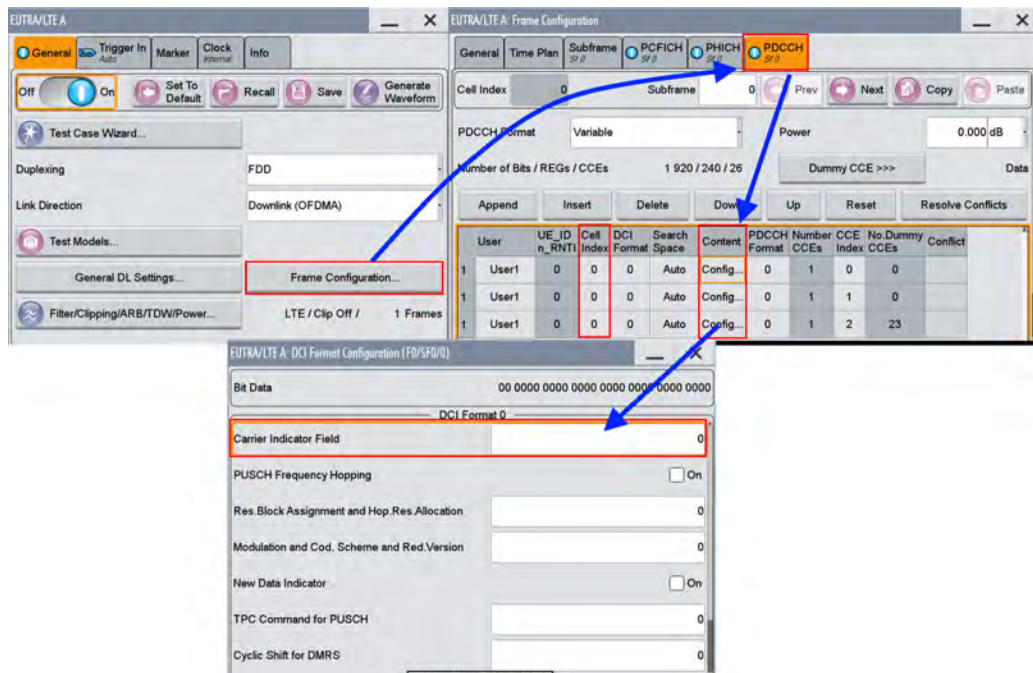

Figure 2-11: Configuring the content of the CFI field for each user

2.2.1.2 CA in the Uplink

The SMW supports CA in the uplink via the **System Configuration** or the direct setup in the baseband. Click in the **EUTRA/LTE** menu *General Settings*.

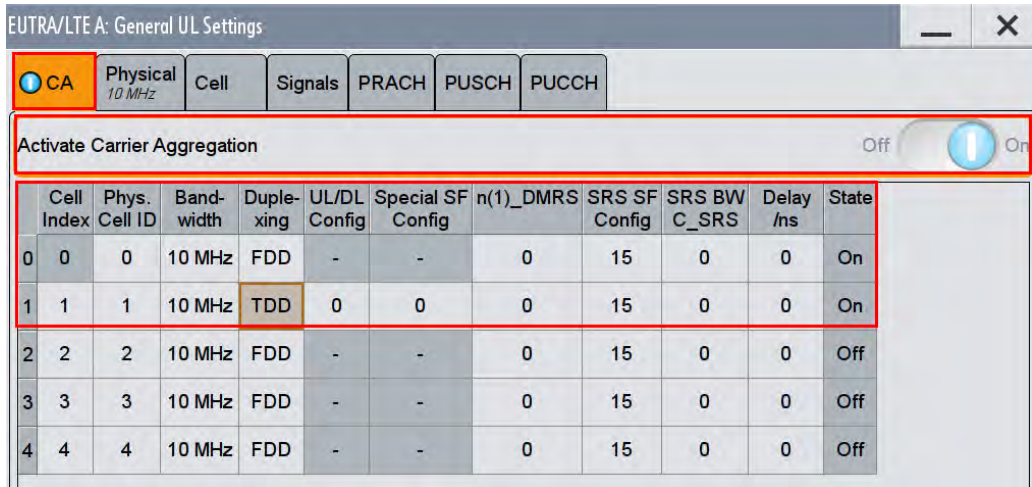

Figure 2-12: SMW: UL Carrier Aggregation

2.2.2 PUCCH format 3

The SMW supports the new PUCCH format 3 for ACK/NACK handling to support multiple cells.

Set in the **UL Frame Configuration** the **PUCCH Modulation/Format** to *F3* and via **Config... Enhanced Settings** in the tab **Channel Coding / Multiplexing** the *Number of Bits* to send and the wanted *Pattern*.

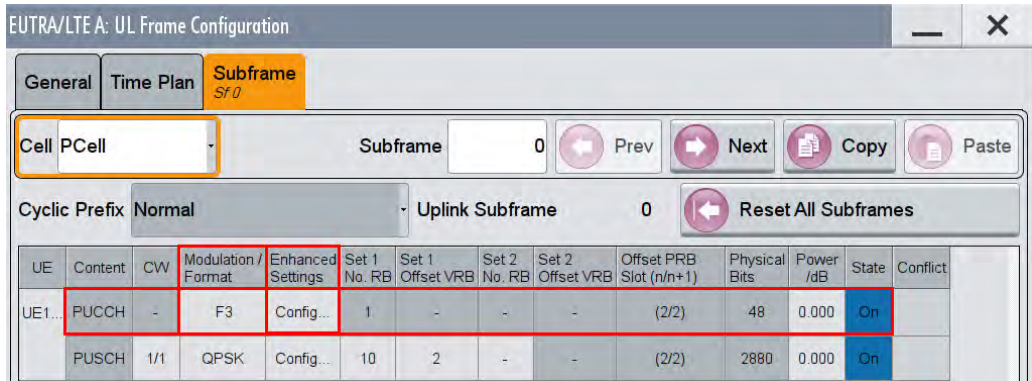

Figure 2-13: SMW PUCCH format 3

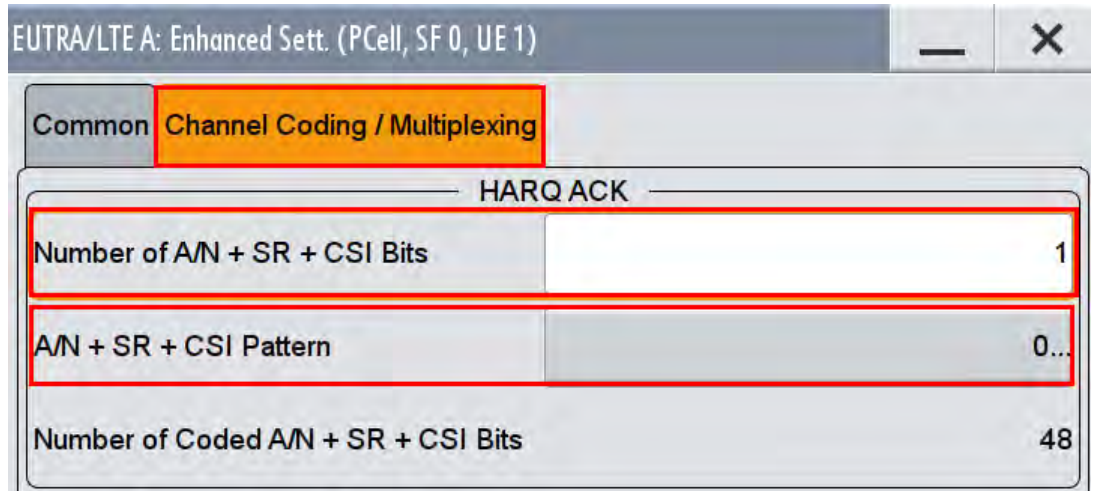
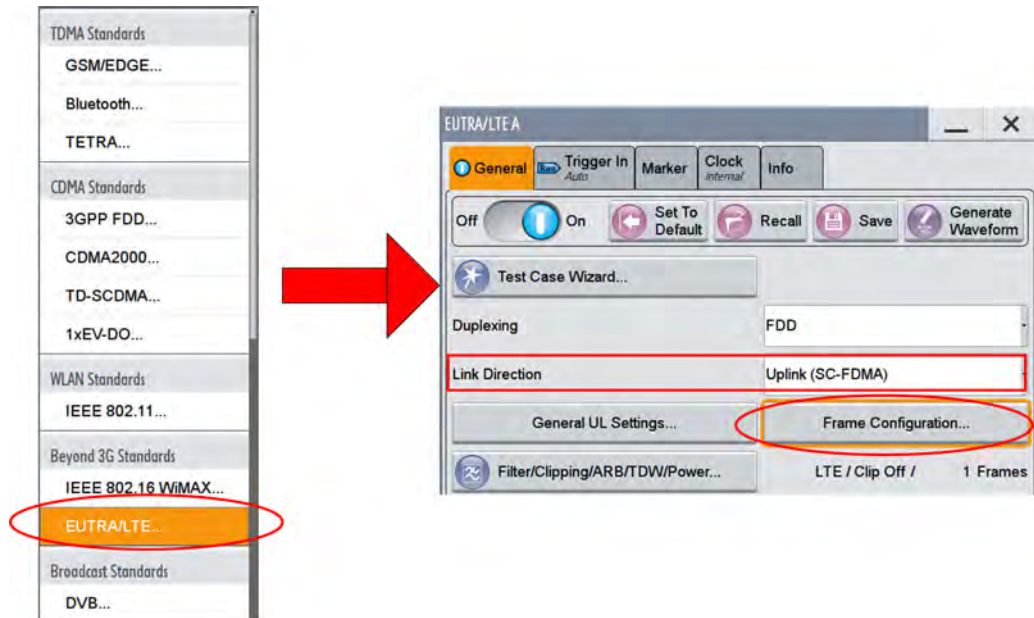

Figure 2-14: SMW: Set the bits to transmit in PUCCH format 3

2.2.3 Enhanced SC-FDMA generation

In order to test e.g. the linearity of a power amplifier design, one would need to generate a 3GPP Release 10 compliant enhanced SC-FDMA signal. This is part of the K85 LTE-Advanced option offered for SMx. After selecting *EUTRA/LTE* from the baseband configuration menu use the *Frame Configuration* menu to configure an individual user device.



The **General** section allows selecting either LTE Rel 8/9 or LTE Rel 10. When using Rel 10 per UE the content field shows simultaneous PUCCH and PUSCH. Two sets of resource blocks can be configured in accordance with 3GPP specifications as illustrated in [Figure 2-15](#).

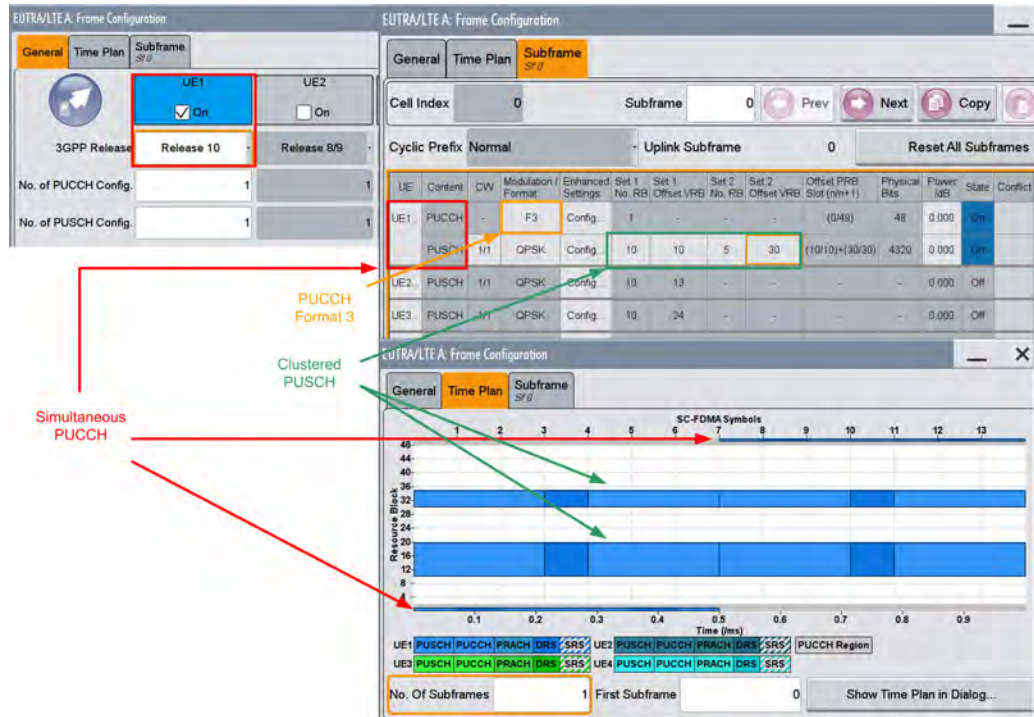

Figure 2-15: Configuring Clustered PUSCH and simultaneous PUCCH/PUSCH

2.2.4 Enhanced MIMO generation

For MIMO tests vector signal generators need to generate different antenna signals simultaneously in parallel. In addition the complete MIMO transmission channel with fading can be simulated.

The SMW can generate up to eight antenna signals simultaneously in its digital baseband – all LTE standard-compliant and with antenna-specific coding. In addition, it can simulate the complete MIMO transmission channel with up to 16 fading channels, sufficient to emulate higher-order MIMO configurations such as 4x4. With the option SMW-K75 higher order MIMO modes like 8x4, 4x8 and 4x4 for 2 component carriers (CC) are possible. As an option in addition fading is available.

The SMBV is able to generate one baseband signal.

2.2.4.1 MIMO in Downlink

With the SMW LTE can generate up to 4x4 MIMO configuration with the needed 16 real time fading channels or a Carrier Aggregation scenario with two component carriers and 2x2 MIMO with independent fading with eight fading channels.

The system configuration feature of the SMW simplifies the necessary settings. For a 4x4 MIMO test a configuration of 1 x 4 x 4 is necessary, for a CA 4x4 MIMO test a configuration of 2 x 4 x 4.

Both tests are described in detail in [5].

The SMW is able to generate the new transmission mode (TM) 9 to support up to eight layer transmissions. Set in the **general settings** of the downlink the **Tx Mode** to *Mode 9*. In the **subframe** settings set **Transmission scheme** to *Multilayer (Tx Mode 9)* and enter the *number of layers*.

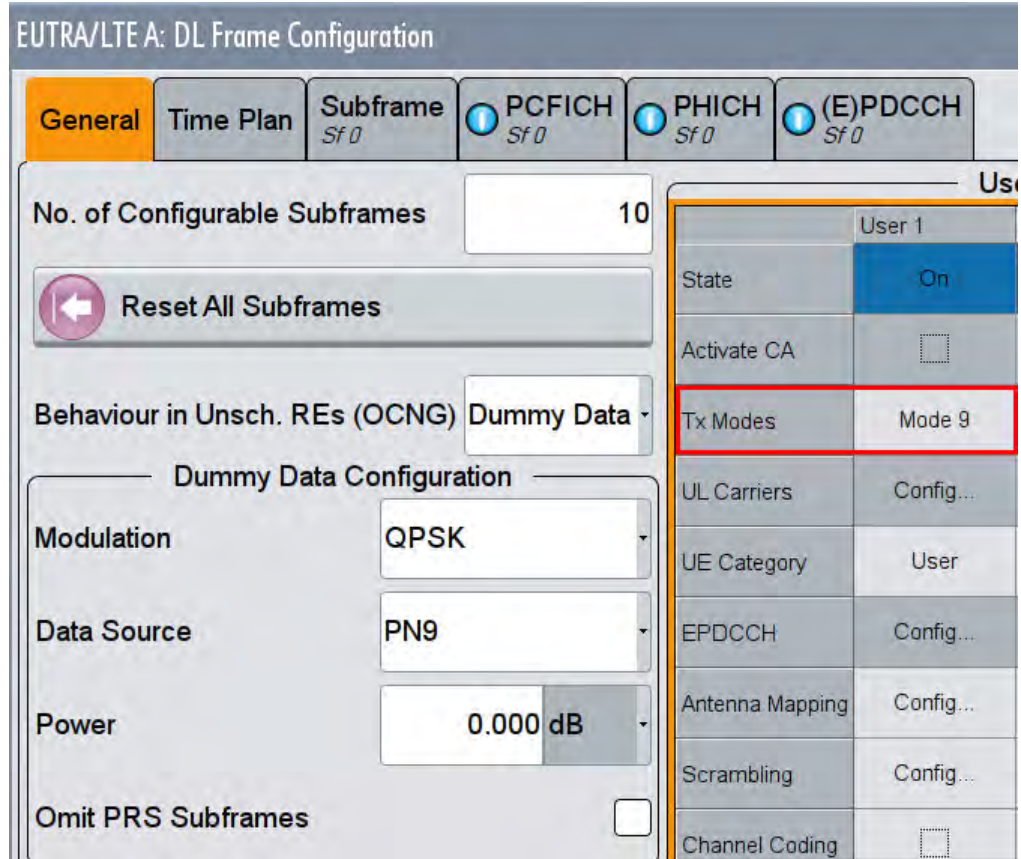

Figure 2-16: SMW: TM9 settings in the general DL frame configuration

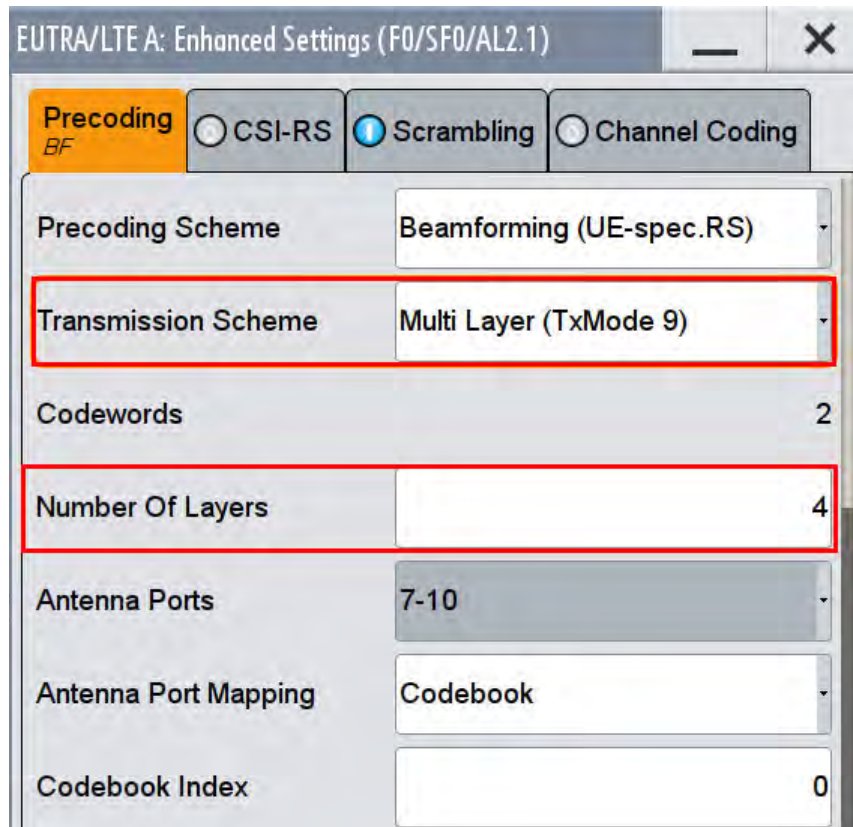

Figure 2-17: SMW: TM9 in the enhanced settings of the subframe, here with four layers

2.2.4.2 MIMO in Uplink

In the uplink up to 4x4 MIMO can be handled in one single SMW (with 2 SGS extensions). Basestation tests use a 2x2 or 2x4 configuration.

As an example a 2x2 MIMO uplink signal is created.

Select in the **System Configuration** 1 x 2 x 2 and *Coupled sources*. This simplifies the settings by configuring the settings in one baseband only.

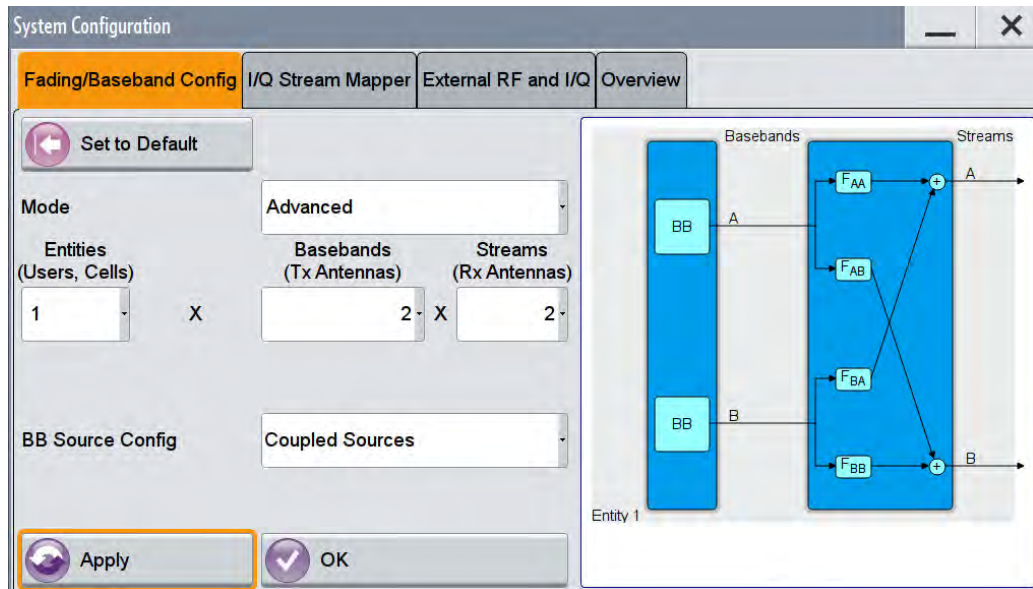

Figure 2-18: The system configuration for a 2x2 Uplink MIMO is 1 x 2 x 2

In the baseband select EUTRA/LTE and set **Link Direction** to *Uplink (SC-FDMA)*. The button **Frame Configurations** shows the already enabled **UE1**. Open the User Equipment configuration by clicking on the UE1.

In the **PUSCH** set the Transmission Mode (TM) to TM2 and the number of Antenna Ports (in this example 2). Check the Antenna Port mapping. Baseband A generates the PUSCH for AP20, Baseband B for AP21 (see Figure 2-19).

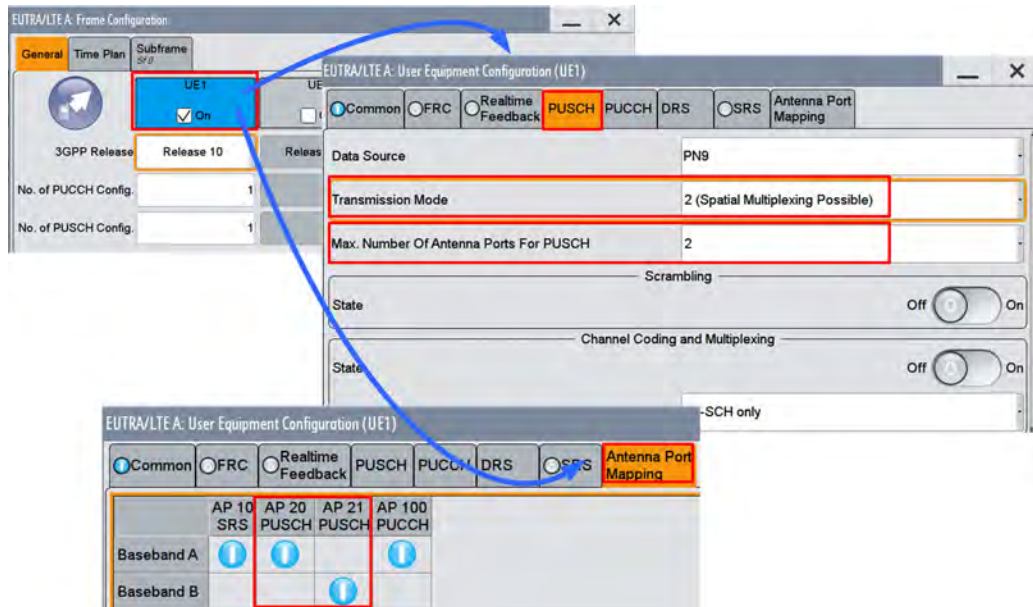

Figure 2-19: The Transmission Mode 2 enables Spatial Multiplexing with up to four antennas (example 2 antennas)

In the **Subframe** section configure the two codewords (CW), e.g. Modulation and resource block allocation (Figure 2-20). In the **enhanced settings Configuration** set the codebook index. For the available codebook indices please see [1]. Please note that for two layers only one codebook index is available (CB 0).

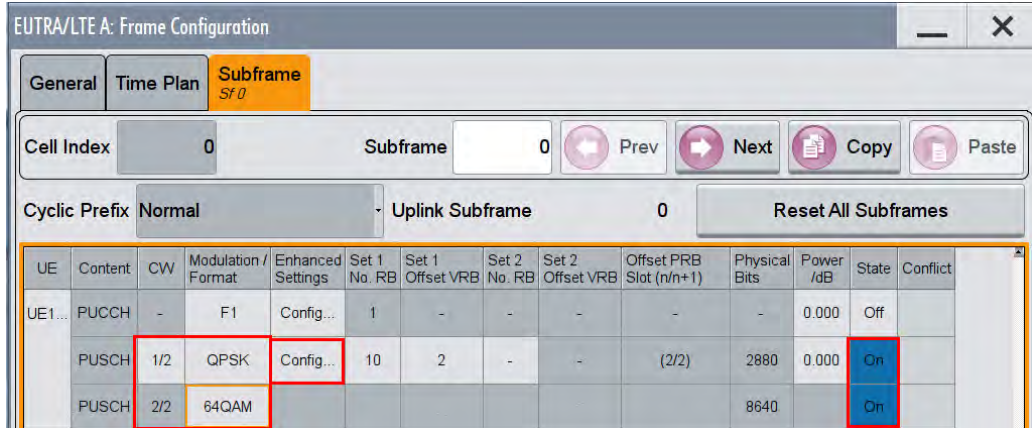

Figure 2-20: Setting the two independent codewords.

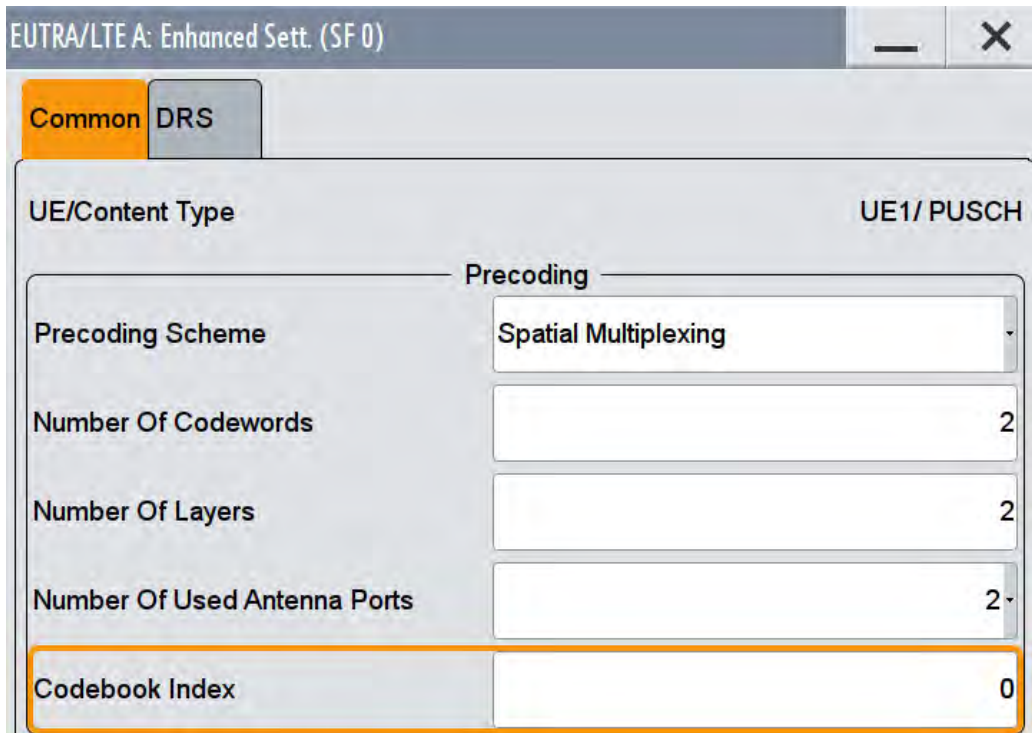

Figure 2-21: Overview of the MIMO settings in the enhanced settings.

2.3 LTE-A signal analysis

For measuring LTE(-A) signals, several different spectrum analyzers can be used for the tests described here:

- FSW
- FSV(R)
- FPS

The **E-UTRA/LTE measurements** software option is available for each of the listed analyzers. The following are available:

- FSx-K100 E-UTRA/LTE FDD downlink measurements
- FSx-K101 E-UTRA/LTE FDD uplink measurements
- FSx-K102 E-UTRA/LTE downlink MIMO measurements
- FSx-K104 E-UTRA/LTE TDD downlink measurements
- FSx-K105 E-UTRA/LTE TDD uplink measurements
- FSx-K103 Analysis of EUTRA LTE-Advanced and MIMO Uplink Signals

Test instruments can also be controlled via the external PC software application E-UTRA/LTE and LTE-Advanced Signal Analysis. The options are named FS-K10xPC. With the software in addition to the above mentioned spectrum analyzers, the oscilloscopes of the RTO family can be used.

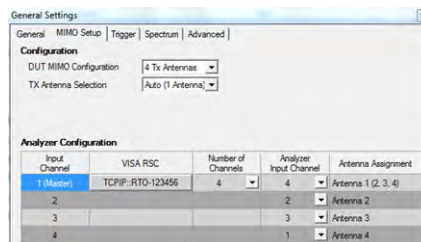

Figure 2-22: Using the RTO for MIMO measurements

Figure 2-22 shows that with FS-K10xPC software it is also possible to use RTO **oscilloscopes** for capturing IQ data as input for the analysis software. This is in particular convenient since the RTO offers up to four input channels.

2.3.1 Carrier aggregation (CA) analysis

When a carrier aggregation signal comprising multiple component carriers is transmitted, each carrier needs to be tested on RF level the same way as in LTE Release 8., e.g. EVM and frequency error measurements. Maximum power measurements need to be performed across all component carriers operated by the base station according to manufacturer declaration. Adjacent band and out of band requirements like transmit intermodulation, ACLR or spurious emissions have to be measured using the most demanding carrier aggregation configuration. E.g. the lower and upper most component carrier is to be switched on, when verifying the corresponding limits for transmit intermodulation tests. Measurements can be done with option FSx-K100/104 (FDD/

TDD) on the Rohde & Schwarz signal analyzer family based on high range signal and spectrum analyzer FSW / FSQ or mid-range signal and spectrum analyzers FSG, FSV(R). Note that testing capabilities will be adapted according to 3GPP developments. See [Figure 2-23](#) providing an example for LTE measurements on a single component carrier.



Figure 2-23: LTE measurements on a single component carrier using FSW-K100

However, for fast and efficient testing of multiple carriers as well as multiple technologies the FSW features the integrated Multi Standard Radio Analyzer (MSRA) option. With the MSRA mode, detailed investigations on multi-standard base stations can be done and interactions between technologies in different frequency bands can be detected. The MSRA mode is based on the analysis of I/Q data. It captures up to 200 Msamples of I/Q data at one moment in time (sufficient for 1 s over a bandwidth of 160 MHz) which can then be analyzed by different measurement applications (e.g. LTE, WCDMA and GSM). [Figure 2-24](#) shows the capture of a LTE-Advanced carrier aggregation signal and a WCDMA signal whereas the LTE-A CA signal has two component carriers with 10 MHz and 20 MHz bandwidth respectively.

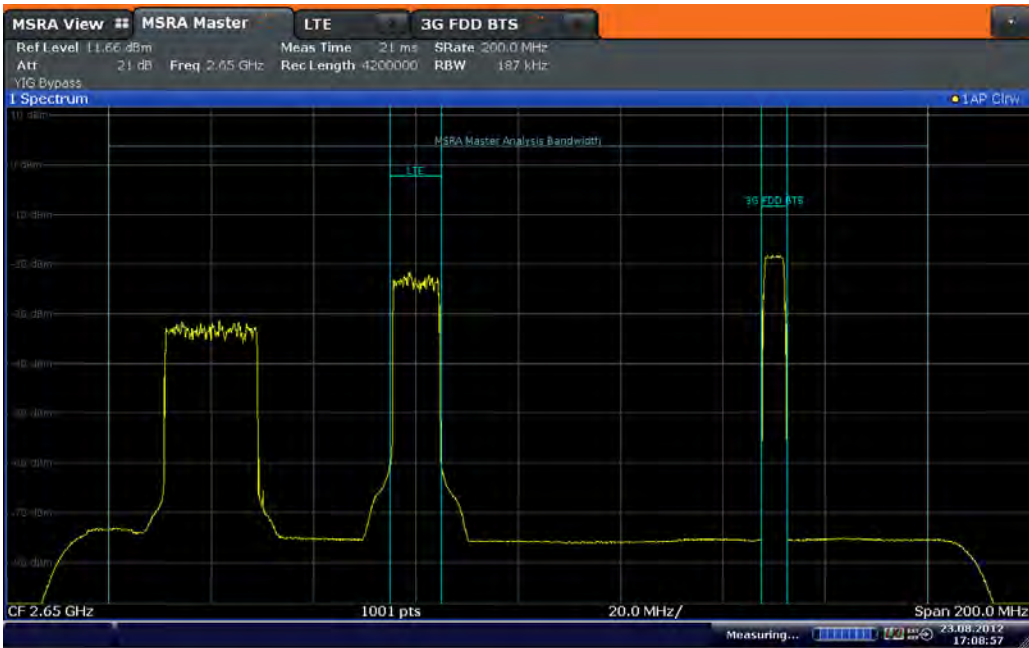

Date: 23 AUG. 2012 17:08:53

Figure 2-24: FSW MSRA spectrum measurement of a multi-technology and multi-carrier signal

Each signal can be analyzed with the corresponding technology option (LTE and WCDMA in the example). Additionally the MSRA view displays both measurement results on a single screen. The type of measurements for each technology can be configured individually.



Date: 23 AUG. 2012 17:08:47

Figure 2-25: FSW MSRA view

The MSRA function as an integrated feature in each FSW is also useful for measuring a LTE-Advanced carrier aggregation signal. Figure 2-26 shows a five component carrier signal with different bandwidth configurations and power offsets. Those carriers of interest may be analyzed configuring different measurements on each carrier according to individual testing needs. Figure 2-25 shows the example of analyzing two out of the five carriers.

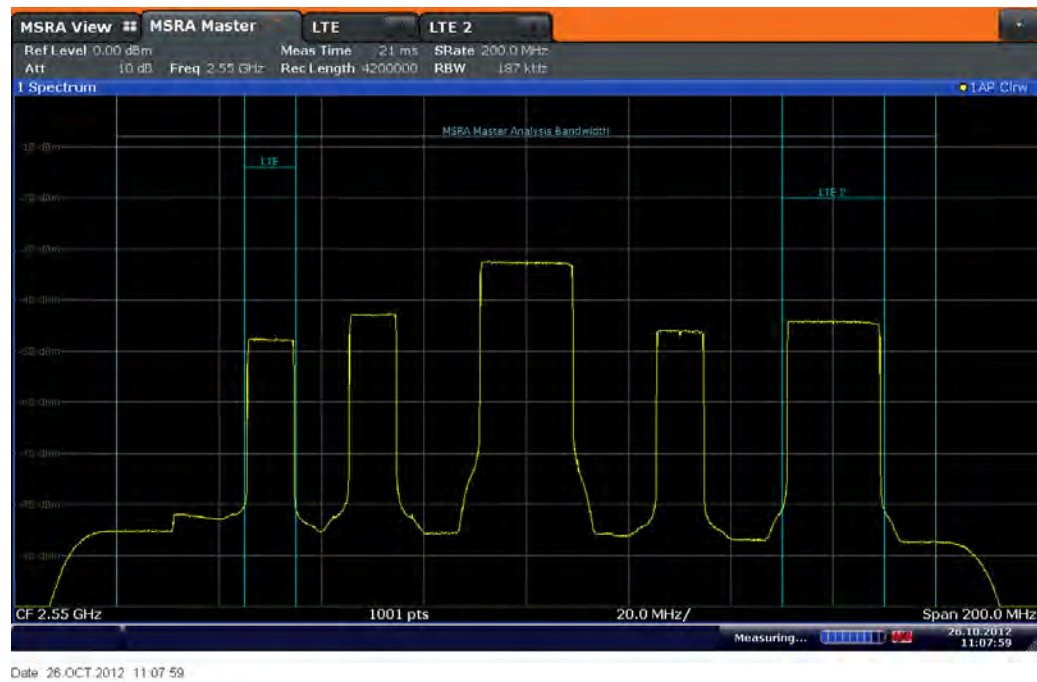

Figure 2-26: MSRA master view of a five component LTE-A carrier aggregation signal



Figure 2-27: MSRA view with different measurements on two of the five components

The MSRA gives R&D engineers valuable insight because it is very easy to find cross talks between different carriers by detecting time correlations between different signals. This becomes possible, since the analysis is performed on the same set of recorded I/Q data.

Time Alignment

Also infrastructure suppliers have to perform dedicated tests for carrier aggregation. One of them is the time alignment error measurement, short TAE. As frames of LTE signals at a base station antenna port are not perfectly aligned, they need to fulfill certain timing requirements. For intra-band carrier aggregation this TAE shall not exceed 155 ns. Inter-band carrier aggregation allows an error of up to 285 ns. These requirements are independent of TX diversity or MIMO applied per component carrier. Figure 2-28 shows the required setup to measure the time alignment error. The external PC software LTE FS-K102PC can be used to control different instruments like the RTO or more than one spectrum analyzer. A stand-alone FSx can be used to measure the TAE if the RF analysis bandwidth is sufficient (e.g. the FSW has a bandwidth up to 2000 MHz). Further details can be found in the related 3GPP specification for LTE base station RF conformance testing [3].

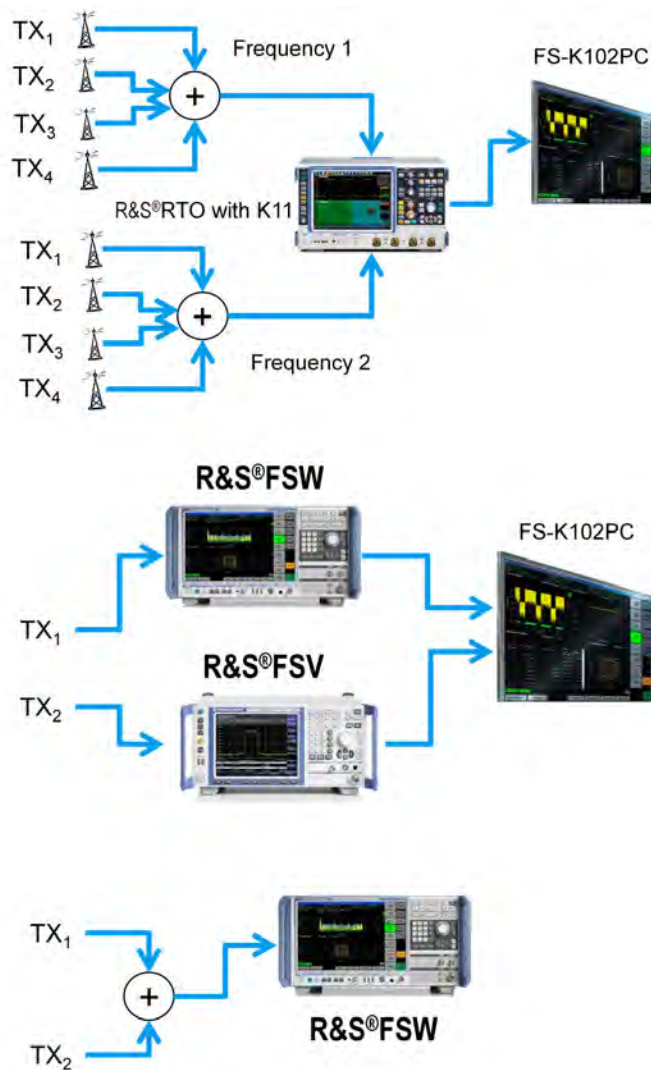

Figure 2-28: different setups measuring TAE for carrier aggregation

2.3.2 Enhanced SC-FDMA analysis

From an RF perspective the main test requirement for enhanced SC-FDMA is to measure the modulation accuracy if both PUCCH and PUSCH are transmitted simultaneously.

Figure 2-29 shows an example measurement using the FS-K10xPC software on top of FSW. FS-K10xPC offers convenient signal analysis due to automatic detection of modulation formats. Each signal subframe is analyzed and the QPSK, 16QAM or 64QAM (DL only) modulation formats plus the length of the cyclic prefix are automatically detected and used in the analysis. Note that whether FS-K10xPC is installed on the instrument or on an external PC, the measurements can be fully automated using well-known SCPI commands. This makes FS-K10xPC ideal for use in automated test systems.



Figure 2-29: Enhanced SC-FDMA measurement using FS-K10xPC software for FSW

General settings and demodulation settings for measuring the signal are illustrated in [Figure 2-30](#)

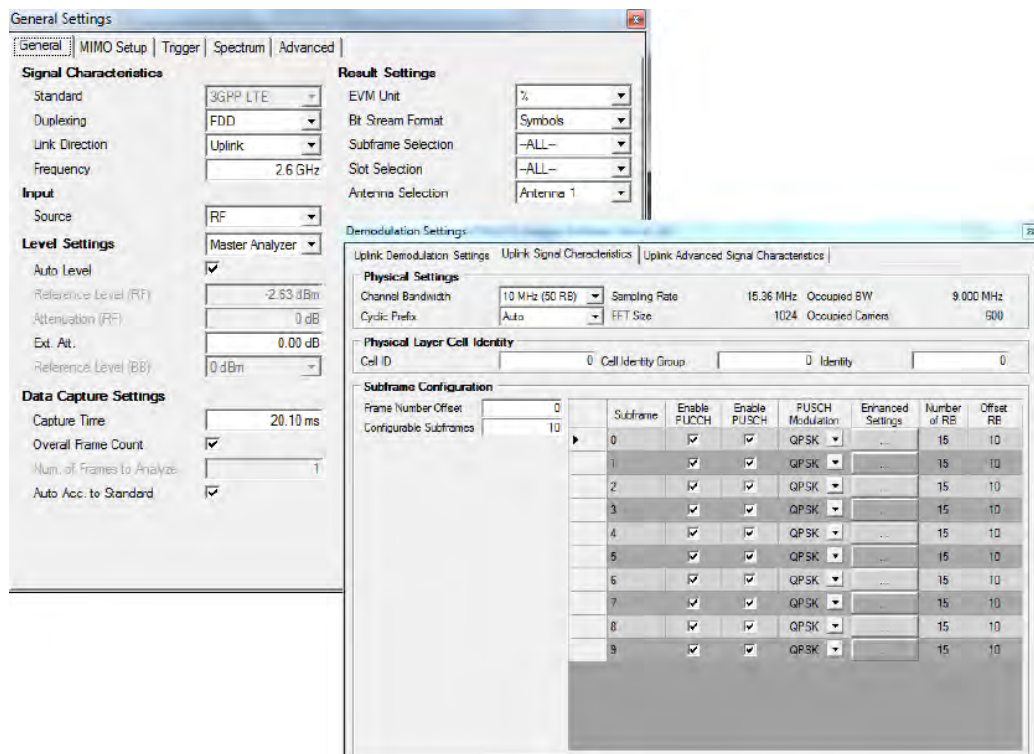

Figure 2-30: Demodulation settings for enhanced SC-FDMA

2.3.3 Enhanced MIMO analysis

MIMO signals are used in LTE-A in the downlink and uplink direction. Both ways can be measured with signal analyzers or the RTO.



Figure 2-31: Test setup with an RTO for measuring a MIMO signal

From an RF perspective one of the measurement tasks for enhanced MIMO schemes is to test an uplink 2x2 signal with regards to modulation accuracy. As the new uplink scheme is similar to the MIMO scheme in downlink direction, testing needs are equally comparable (for comparison see [4]). In order to measure the uplink 2x2 MIMO signal two analyzers or one RTO are required. Figure 2-32 illustrates the principle test setup using as an example a FSW and a FSQ for capturing the IQ data and FS-K10xPC software to analyze the results. For this example an uplink LTE TDD signal is analyzed.

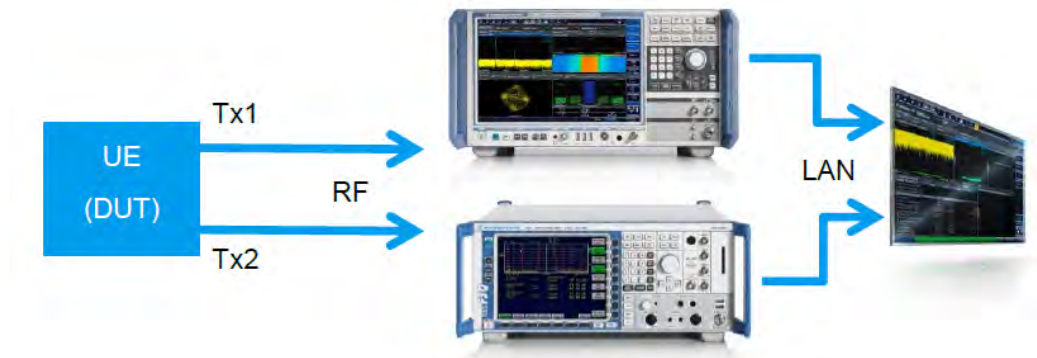

Figure 2-32: Test setup for measuring a 2x2 uplink MIMO signal

Figure 2-33 illustrates the general settings and Figure 2-34 provides the demodulation settings required to execute the measurement.

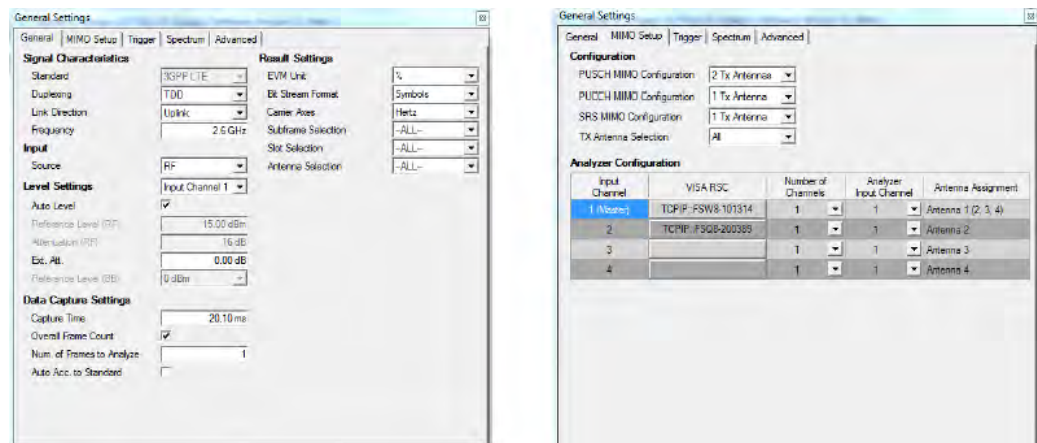

Figure 2-33: General settings to measure an uplink 2x2 MIMO LTE TDD signal (10 MHz)

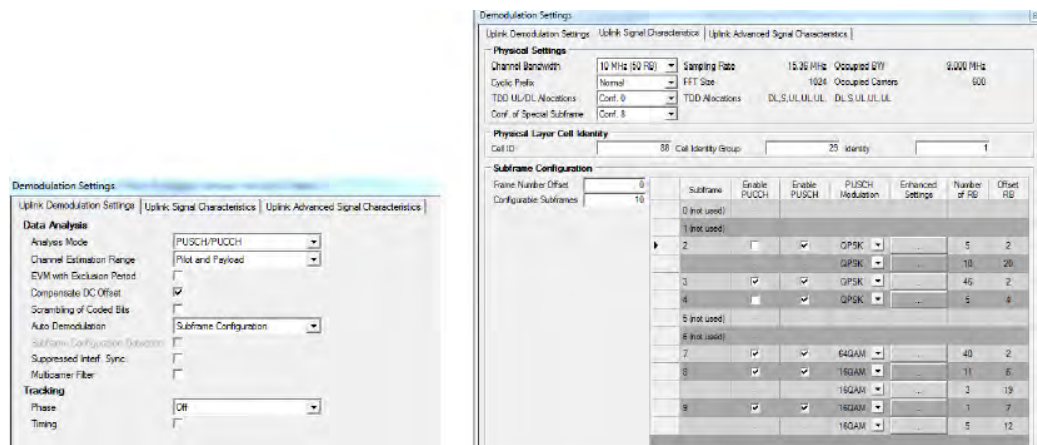

Figure 2-34: General settings to measure an uplink 2x2 MIMO LTE TDD signal (10 MHz)

Figure 2-35 and Figure 2-36 show the results using the settings described above. The result view may be configured according to individual testing needs.

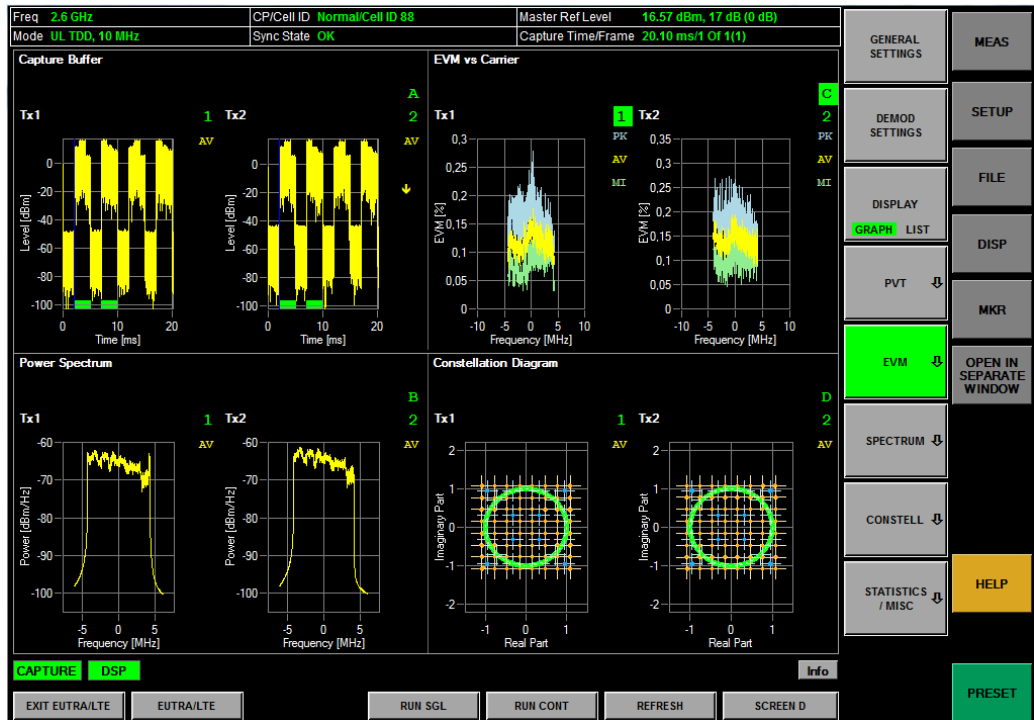

Figure 2-35: Power versus time / frequency measurements, EVM measurements and constellation diagram for each Tx antenna summarized in the multiple screen view



Figure 2-36: EVM measurements in tabular format for one selected TX antenna in single screen view

2.4 LTE-A with the CMW500

The CMW can be used as a protocol tester (message analysis) as well as a radio communication tester (call box, RF test).

In addition to LTE-A, the CMW offers other radio communication standards, including W-CDMA (with HSPA+), GSM, CDMA2000, 1x-EV-DO and so on. This makes it possible to test InterRAT scenarios, such as LTE handover to GSM or W-CDMA.

Equipped with powerful hardware and various interfaces to wireless devices, the CMW can be used throughout all phases of LTE-A device development – from the initial module test up to the integration of software and chipset, as well as for conformance and performance tests of the protocol stack of 3GPP standard-compliant wireless devices, see [Figure 2-37](#)

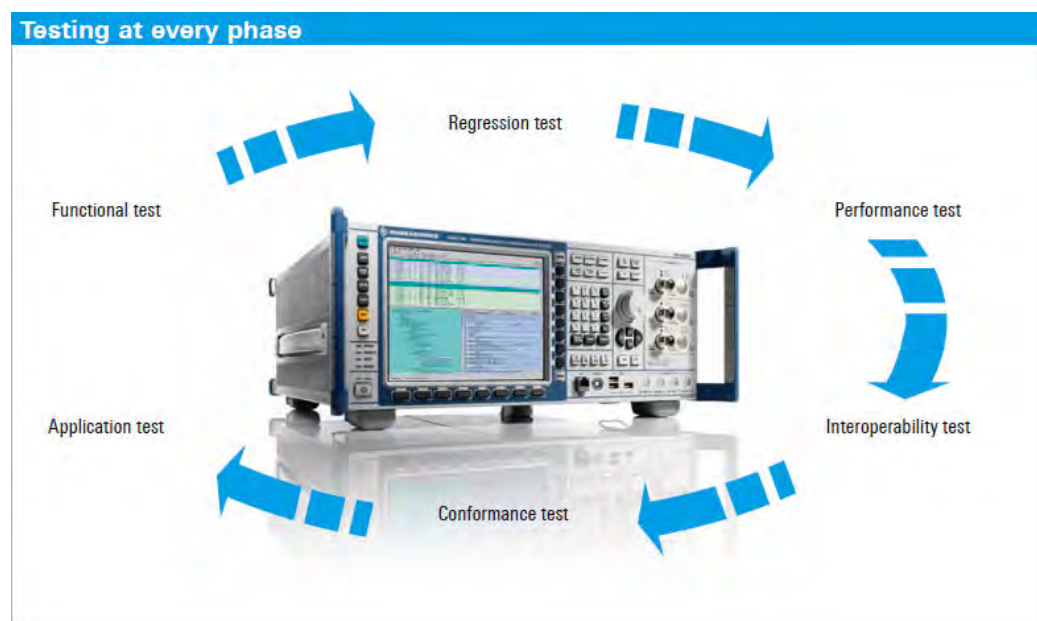

Figure 2-37: Consistent hardware and software concept for all device development phases.

MIMO and Carrier Aggregation

The CMW (protocol tester and callbox) supports different transmission and MIMO modes like 8x2 MIMO and carrier aggregation up to five (5) component carriers (CC) and MIMO in parallel like CA with 4x4 MIMO. The CMW supports all possible frequency allocations in CA (intra-band contiguous, intra-band non-contiguous and inter-band). All CC's can be set up independently of each other.

Carrier Aggregation with CMWflexx

The CMWflexx provides more than 2 CC's with MIMO each, therefore more than one CMW is used. The CMW Controller (CMWC) allows easy manual and remote control, it acts like one CMW with extended RF hardware.

2.4.1 LTE-A in the CMW protocol tester

The device under test (a chip set or terminal) is connected to a network emulator, which simulates all required network functions and protocols. However, errors may occur in all layers (physical layer, Layer 2/3, application layer) and throughout the whole development cycle (R&D, conformance, production). Thus any test instrument needs to offer manifold analysis capabilities. Rohde & Schwarz offers the CMW500 wideband radio communication tester, which provides all necessary functions within a single test instrument.

Different bandwidths per component carrier, up to 20 MHz each, are supported. CMW500 supports all variances of carrier aggregation in one single instrument: intra-band (contiguous, non-contiguous) and inter-band. Already today the instrument supports all 3GPP frequency bands that are utilized for LTE.

First of all the tester and the DUT have to run throughout a successful LTE-A channel setup. I.e. the signaling procedure from starting with a LTE Rel8 setup and adding secondary component carriers (SCC's) has to be verified on all relevant protocol layers (PHY, MAC and RRC). This would typically be done using a CMW500 in protocol test configuration. Example scenarios are available for lower layer API (LLAPI) and medium layer API (MLAPI) as well as the graphical user interface CMWcards. [Figure 2-38](#) shows example physical layer scenarios using different configurations for primary and secondary cells as well as different transmission modes.

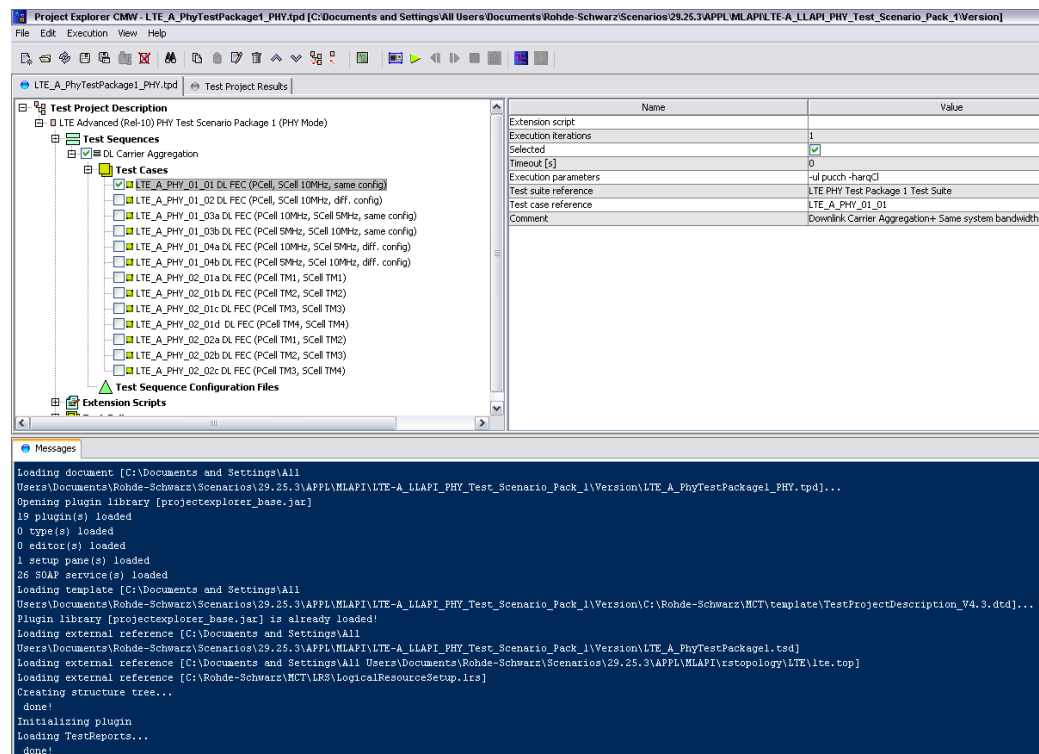

Figure 2-38: Physical layer example scenario for carrier aggregation

MLAPI

In order to verify the signaling communication on layer 2 and 3, MLAPI scenarios are available. These can be used as provided in various test scenario packages. Additionally existing scenarios may be modified according to the individual testing needs.

Following MLAPI scenarios packages with Release 10 features are available:

Table 2-1: MLAPI Scenario Packages Rel 10

Scenario Packages Rel 10		
Name	Description	Remark
PHY and L2 Verification		
CMW-KF513	CA / eICIC	
CMW-KF518	3 CA DL / CoMP / TM10	
Full Stack Verification		
CMW-KF514	CA Mobility	
CMW-KF515	eICIC / feICIC	
CMW-KU503	LTE Rel. 9-12 MTC MLAPI Scenario PACK, MTC-, IoT-, M2M-Test Scenarios to test CAT0, EAB, Extended Wait Time	

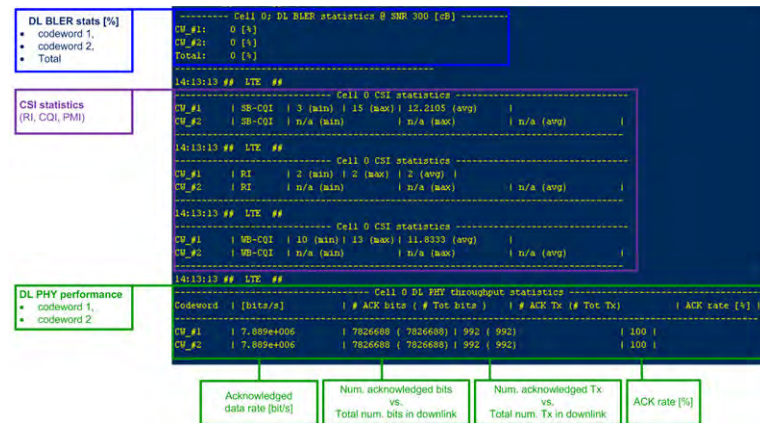

Figure 2-39: MLAPI KPI collection.

CMWcards

CMWcards is a graphical test case creation tool for signaling and application tests on CMW500 mobile radio tester.

Create wireless signaling and application tests on the CMW500 wideband radio communication tester just by setting up a hand of cards – no programming required.

Thanks to the CMW500 tester’s unrivaled multitechnology capability, CMW-KT022 CMWcards can be utilized to rapidly reproduce signaling scenarios for various wireless communications standards just like LTE, WCDMA, GSM as well as WLAN.

CMWcards includes test coverage for LTE-advanced up to Release 10 features such as carrier aggregation.



Figure 2-40: Overview CMWcards

CMWmars

Efficiently analyze recorded message logfiles. The convenient, intuitive CMWmars message analyzer user interface combined with various tools and views helps users quickly narrow down the root cause of signaling protocol and lower layer problems. The multifunctional logfile analyzer provides access to all information elements of all protocol layers for LTE, WCDMA, GSM, TD-SCDMA, CDMA2000® and WLAN, including the IP layer. CMWmars presents the logfile in various synchronized views that visualize the data from different perspectives, helping users to postprocess complex message logs in a very intuitive and easy way.

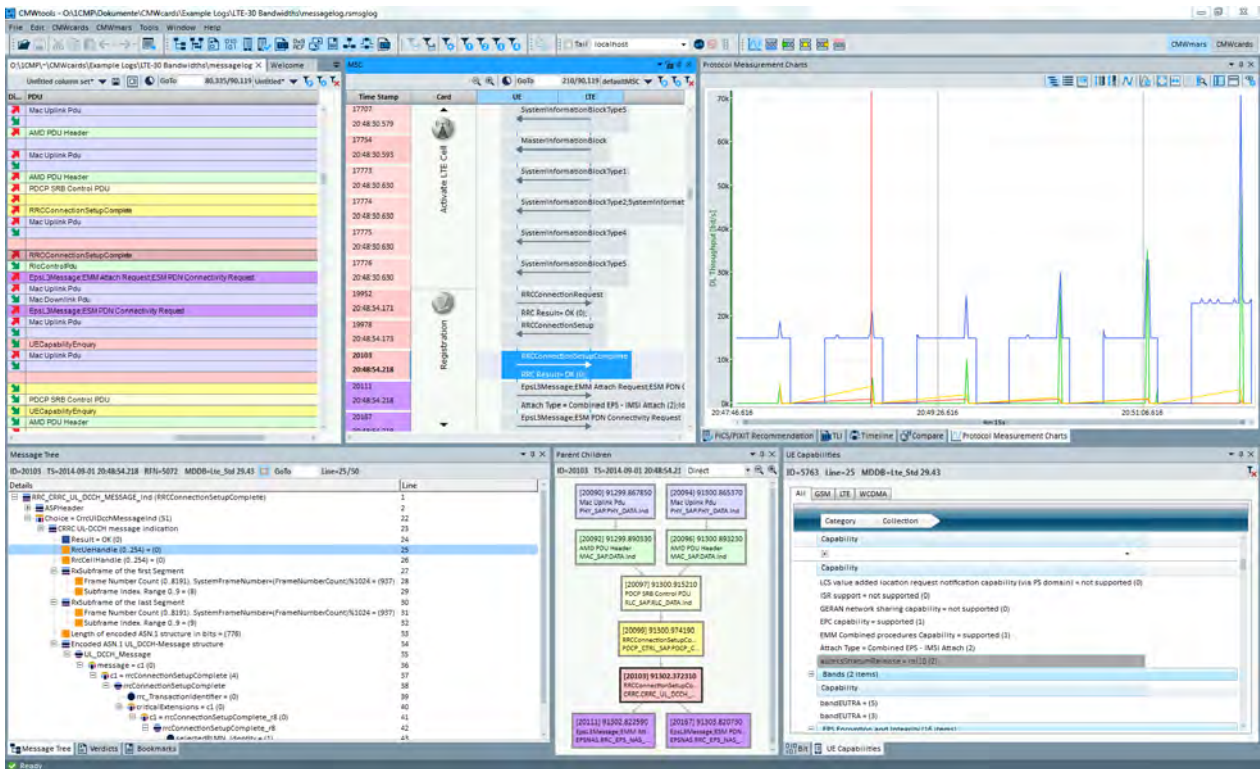

Figure 2-41: Overview CMWmars.

Uplink – TX Measurements

Furthermore there is a need to verify the uplink signal transmitted by the device when in downlink direction e.g. two component carriers are received. All relevant measurements are available with the CMW500. The RF uplink measurements can be done in parallel to a MLAPI test scenario or in the RF tester environment. These measurements do not differ from LTE Release 8 uplink TX measurements if only one uplink carrier is used. The CMW also supports uplink carrier aggregation measurements (see next section).

2.4.2 LTE-A in the CMW RF tester ("call box")

When used as an RF tester, the CMW provides a generator for the LTE downlink and an analyzer for the LTE uplink signal. The CMW can also emulate network operation ("signaling") under realistic conditions for RF tests. The CMW supports carrier aggregation up to five (5) component carriers (CC) and MIMO in parallel like CA with 4x4 MIMO (CMWflex).

2.4.2.1 Transmitter tests (TX)

Measurements on the TX side of the DUT are made possible with the LTE Multi Evaluation option (see Figure 2-42).

The overview screen provides all measured results and scalar values for the essential measurements: UE power, error vector magnitude (EVM) root mean square (RMS)

power, RB allocation table and spectrum measurements. Because measurements results are based on the same set of data, the individual results relate to each other, thus facilitating troubleshooting and debugging.



Figure 2-42: Tx measurements of a DUT uplink signal using CMW500

The overview display in multi-evaluation mode can be adapted to the individual testing needs. For example, it may be necessary to closely monitor only two measurement results, or just one measurement result with a comparison of maximum and average values. The overview display can be configured to meet individual needs.

These measurements do not differ from LTE Release 8 uplink TX measurements if only one uplink carrier is used. If two uplink carriers are used, the modulation measurements, e.g. EVM, can be done on each CC. Measurements like inband emission, power monitor and RB allocation table can be done at the same time. Spectrum measurements (Spectrum ACLR and Spectrum emission mask) are measured for the aggregated bandwidth for CC's together for intra-band contiguous uplink CA.

2.4.2.2 Signaling and receiver tests (RX)

The CMW can optionally provide signaling. The "LTE signaling" firmware application (option KS5xx) allows users to emulate an E-UTRA cell and to communicate with the UE under test. The UE can synchronize to the DL signal and register.

This means that RX tests, e.g. ACK/NACK measurements (BLER, throughput), can be performed in test mode on the DUT.

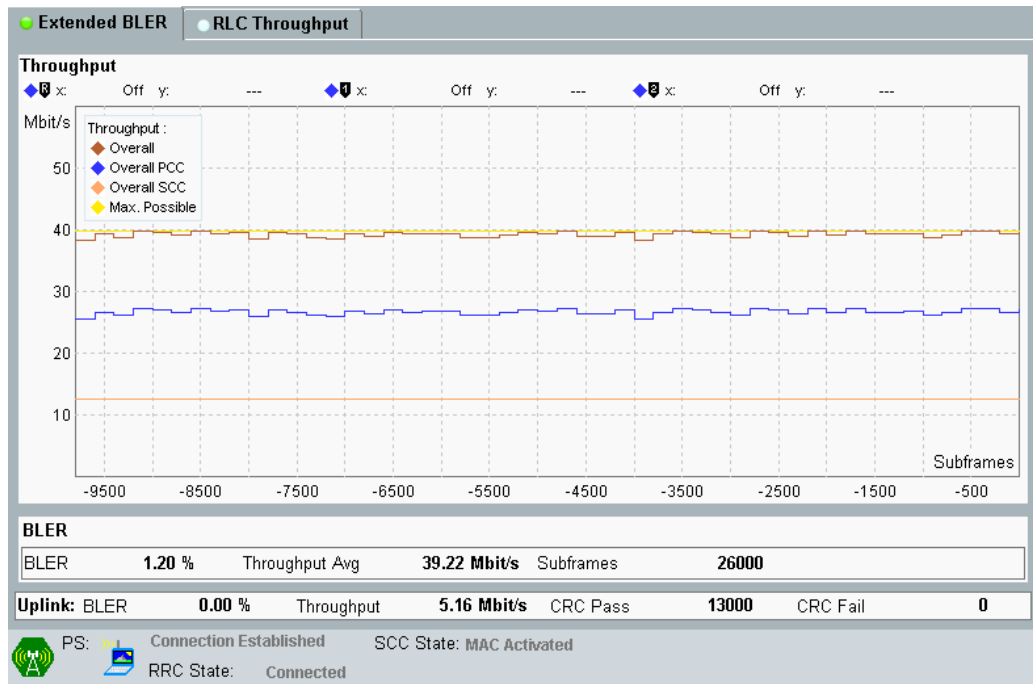

Figure 2-43: LTE RX measurement for Carrier Aggregation. The throughput for both CCs and the overall throughput are displayed.

End-to-end data tests can be performed using the DAU (see the next section).

2.4.3 Data Application Unit (DAU) for CMW

The "Data Application Unit" (option B450A) makes it possible to test data transfer via TCP/IP or UDP/IP. It allows users to run Internet Protocol (IP) services on the CMW, such as file transfer and Web browsing. The DAU provides a common and consistent data testing solution on the CMW for all supported radio access technologies.

The DAU is required when testing End-to-End (E2E) IP data transfer as well as when using the instrument for protocol testing (U-plane tests). Together with the DAU, IP-based measurement (option KM050) applications allow users to test and measure the properties of the IP connection, such as network latency or performance. The measurements support Internet protocols IPv4 (option KA100) and IPv6 (option KA150 on top of KA100).

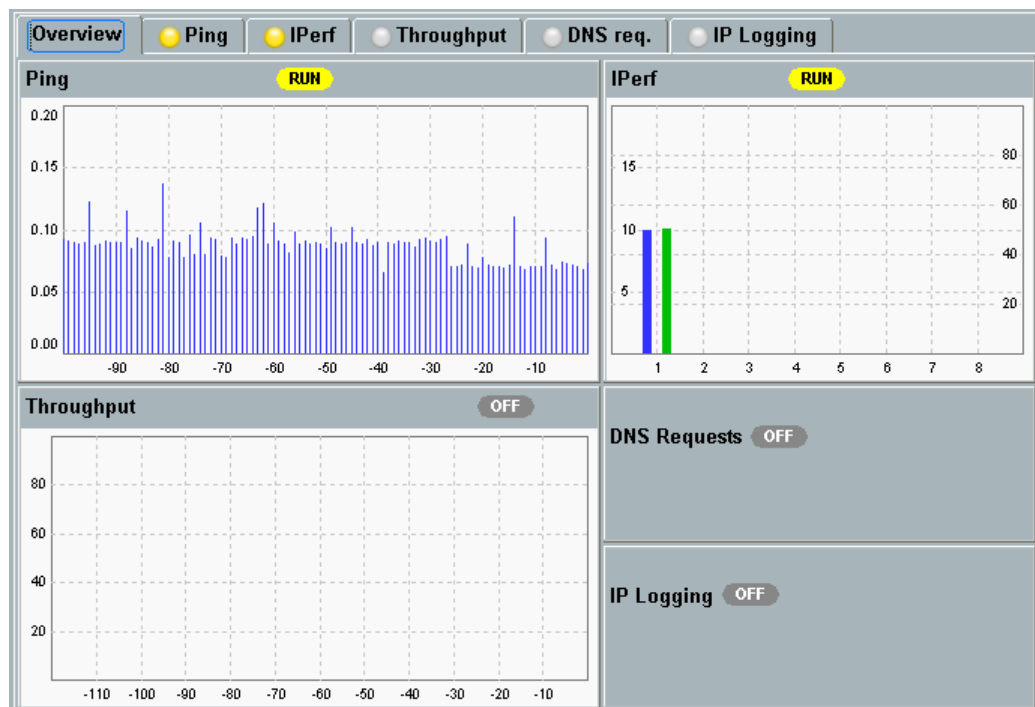

Figure 2-44: Overview of the tests in the data application unit. PING, IPerf and Throughput at a glance.

2.4.4 Channel Simulation - fading

In order to simulate a channel for UE receiver tests, the CMW provides internal fading with predefined profiles as an option:

- Delay profiles (3GPP TS 36.101, Annex B.2.)
 - For 2x2 MIMO all with low, mid and high correlation:
 - EPA 5 Hz
 - EVA 5 Hz
 - EVA 70 Hz
 - ETU 30 Hz
 - ETU 70 Hz
 - ETU 300 Hz
- High speed train profile (HST) (3GPP TS 36.101, Annex B.3.)
- Multi-path profile for CQI tests (3GPP TS 36.521-1, section 9.3.)

Various options permit a variety of MIMO configurations; see the Ordering Information (4.3).

In addition, the CMW can be connected to the SMW via optional digital IQ interfaces. The SMW provides the MIMO matrix channels (e.g. 4x2), adds AWGN and fades all matrix channels. The MIMO cross components can be faded independently of one another (e.g. for CA with 2x2 MIMO). The SMW has predefined fading profiles for LTE in accordance to specification. In addition the fading parameters can be changed separately.

2.5 RF conformance Test System TS8980

UEs have to pass various test phases during their development. In the early phase of R&D, the different components of the UE like baseband and RF part are tested independently from each other.

During this time radio communication testers, signal generators (SG) and signal analyzers (SA) are used typically in non-signaling test environments in order to investigate RF receiver and transmitter characteristics of the UE. Pure baseband tests can be done by using simulation and verification using the IQ-interface of the UE which is connected to the IQ-interface of channel emulators, SA and SG. As soon as a logical and physical call setup can be established, further tests on UE prototypes can be performed with the help of a signaling unit (SU) fitted to a radio communication tester like CMW.

Chipset and UE manufacturers will apply differing test specifications. There are internally defined specs which are based on knowledge and prior experience. This is a main part of the test area. Other tests are derived from i.e. the 3GPP test specifications like [TS 36.521]. As maturity of a UE design increases, more testing conditions are added. "House" test specifications as well as [TS 36.521] contain LTE test scenarios with fading and interference conditions. Additionally, extreme test conditions with varying environmental factors like supply voltage, humidity and temperature are defined for a UE.

Automated test systems like TS8980 with onboard components of SU, SG and SA are able to provide the widest range of such testing conditions. In a pre-conformance context, the user friendly flexibility to change testing parameters like effects of fading and interference as well as tools to find the real design limits in an automated and hence repeatable way are essential. After all, no flaw should pass unnoticed before entering the final stage to market: UE RF certification.

The type approval or certification of UEs according to GCF, PTCRB or a given set of Network Operator test plans is the next phase. GCF and PTCRB requirements typically consist of a subset of otherwise unchanged tests from the 3GPP test specifications.

Network Operator RF test plans usually consist of two types of tests:

- those based on 3GPP with extensions and/or tighter limits, based on an operator's own experience
- completely new tests as defined
 - to protect other services (like Digital TV, ATC Radar, Geolocation services)
 - ensure UE performance is not unduly compromised in the vicinity of such other services.

Reproducible and precise measurements are crucial for type approval test systems like the TS8980FTA. Apart from basic accuracy, built-in functions for user-guidance on and/or full automation of calibration is a pre-requisite for a test system to function as an arbiter of UE performance.



Figure 2-45: The test system TS8980FTA-2

The TS8980 family of test systems offers the most complete coverage in the industry for applications in GSM, W-CDMA and LTE test. TS8980 is used by all leading test houses, first-rate chipset and UE manufacturers, and major network operators.

UTRA and E-UTRA Conformance test in line with GCF and PTCRB as used by labs accredited for certification of mobile devices are complemented by a very broad range of acceptance test packages as defined by many of the leading Network Operators.

The highly user friendly CONTEST graphical user interface gives control over test case execution, automation of DUT, Climatic chamber, DC supply and other external devices. The GUI also comes with a brace of functions for DUT management and standard-compliant result reporting as well as internal and external data base control for result handling, documentation and storage. It allows to perform the CA test cases according to the 3GPP test specification or to set the bandwidths and frequencies individually.

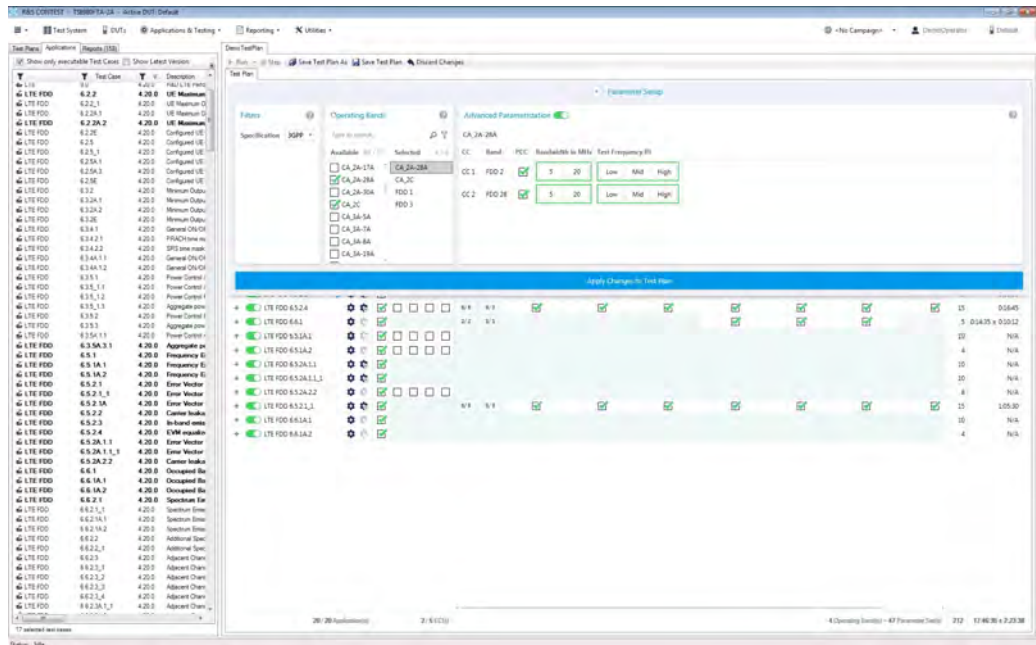

Figure 2-46: Contest testplan editor

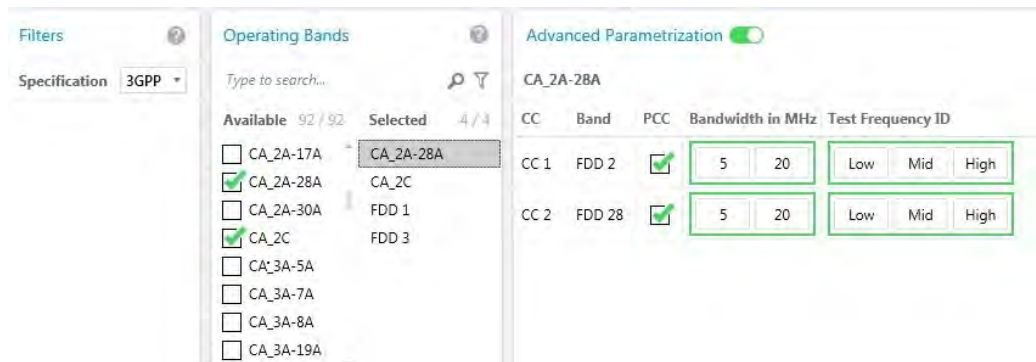

Figure 2-47: CA band combinations in Contest

Margin Search routines and Performance Evaluation modes allow to evaluate the headroom a DUT has vs certification-level PASS criteria or vs user-specified minimum values.

RF test for LTE and W-CDMA may be combined with RRM conformance for LTE / W-CDMA.

Test Case Packages

Available validated test case packages for LTE-A are

- CA-DL 2CC
- e DL MIMO
- eICIC

3 Appendix

3.1 Literature

- [1] Rohde & Schwarz: White Paper 1MA169 “LTE-Advanced Technology Introduction”
- [2] Rohde & Schwarz: Application Note 1GP84 “Time Synchronous Signals with Multiple R&S®SMBV100A Vector Signal Generators”
- [3] Rohde & Schwarz: Application Note 1MA198 “Measuring Multistandard Radio Base Stations”
- [4] Rohde & Schwarz: Application Note 1MA143 “LTE Downlink MIMO Verification with R&S®SMU200A and R&S®FSQ”
- [5] Rohde & Schwarz: Application Note 1GP97 “Higher Order MIMO Testing with the SMW200A”

3.2 Additional Information

Please send your comments and suggestions regarding this white paper to TM-Applications@rohde-schwarz.com

3.3 Ordering information

Please visit the Rohde & Schwarz product websites at www.rohde-schwarz.com for ordering information on the following Rohde & Schwarz products or contact your local Rohde & Schwarz sales office for further assistance.

Vector Signal Generators

[SMW200A vector signal generator](#)

[SGS100A vector signal generator](#)

[SGT100A vector signal generator](#)

Signal and Spectrum Analyzer

[FSW signal and spectrum analyzer](#)

[FSV3000 signal and spectrum analyzer](#)

[FSVA3000 signal and spectrum analyzer](#)

Radio Communication Tester

CMW wideband radiocommunication tester

Test Systems

TS8980 Conformance test system